

# **NORTH CAROLINA BASIC CHILD PASSENGER SAFETY TRAINING PROGRAM**

## **PARTICIPANT MANUAL**

September 2005



# PREVIEW COPY

**This training curriculum was developed by the North Carolina Child Passenger Safety Training Committee with funding from the North Carolina Governor's Highway Safety Program.**

**The information contained within this manual was current at the time of printing. However, child passenger safety is a dynamic and ever changing field. Persons using this manual must stay abreast of changes to this information in order to provide accurate information to parents and other caregivers.**

## NC CHILD PASSENGER SAFETY TRAINING AND CURRICULUM COMMITTEE

Mr. Tony Asión  
Public Safety Director  
El Pueblo, Inc.  
Raleigh, NC

Sgt. Billy Brown  
Traffic Safety Information Officer  
NC State Highway Patrol  
Troop A Headquarters  
Greenville, NC

Ms. Paula Bryson  
Coordinator  
WNC Safe Kids  
Mission St. Josephs Hospital  
Asheville, NC

Ms. Gayle Buchler  
Highway Safety Specialist  
NC Governor's Highway Safety Program  
Raleigh, NC

Mr. Bill Hall  
Manager  
NC CPS Resource Center  
UNC Highway Safety Research Center  
Chapel Hill, NC

Ms. Betty Johnsey  
Injury Prevention Educator  
Lenoir County SAFE KIDS /  
Safe Communities  
Lenoir Memorial Hospital  
Kinston, NC

Ms. Connie Lawson  
Health Educator  
Guilford County Health Department  
High Point, NC

Mr. Larry McMahon  
VA State Police (Retired)  
Southport, NC

Mr. Eric Morrison  
Community Relations Coordinator  
Mecklenburg EMS Agency  
Charlotte, NC

Ms. Jan Parker  
Fire and Life Safety Educator  
Raleigh Fire Department  
Raleigh, NC

Mr. Jody Piatt  
Durham Police Department (Retired)  
Bahama, NC

Ms. Kelly Ransdell  
Deputy Director  
Office of the State Fire Marshal  
NC Department of Insurance  
Raleigh, NC

Mr. Mike Whitehurst  
Coordinator  
EMS Education Department  
Albemarle Hospital  
Elizabeth City, NC

Ms. Kim Wittig  
Fire and Life Safety Educator  
Rocky Mount Fire Department  
Rocky Mount, NC

**NC CHILD PASSENGER SAFETY TRAINING COMMITTEE SUPPORT**

Ms. Allison Cummings  
Injury Prevention Coordinator  
Office of State Fire Marshal  
NC Department of Insurance  
Raleigh, NC

Mr. Allan Buchanan  
Injury Prevention Specialist, Central  
Region  
Office of State Fire Marshal  
NC Department of Insurance  
Raleigh, NC

Ms. Angie Gregg  
Injury Prevention Specialist, West  
Region  
Office of State Fire Marshal  
NC Department of Insurance  
Raleigh, NC

Mr. Stuart Jones  
Injury Prevention Specialist, Eastern  
Region  
Office of State Fire Marshal  
NC Department of Insurance  
Raleigh, NC

**PREVIEW COPY**

# TABLE OF CONTENTS

UNIT 1: INTRODUCTION AND COURSE OBJECTIVES .....	1
Why Are We Here? .....	1
Focus and Purpose of the NC CPS Basic Awareness Class .....	1
Liability Issues .....	2
Objectives of this Course .....	3
UNIT 2: THE NEED FOR CHILD RESTRAINTS AND NORTH CAROLINA'S OCCUPANT RESTRAINT LAWS .....	5
The Need for Child Restraints .....	5
Crashes Are Not Accidents .....	5
North Carolina's Occupant Restraint Laws .....	5
Legal Vs. Best Practice Recommendations .....	9
UNIT 3: HOW RESTRAINTS PROTECT OCCUPANTS IN CRASHES .....	11
What Happens In a Crash .....	11
Four Types of Crashes .....	12
How Restraints Protect Occupants .....	13
Types of Occupant Restraint Systems .....	13
Unsurvivable Crashes .....	16
Occupant Protection Systems after a Crash .....	16
UNIT 4: CHOOSING THE "BEST" CHILD RESTRAINT .....	19
What is the best car seat? .....	19
Are used child restraints okay? .....	19
Defects and Recalls .....	20
After Market Products and Safety Standards .....	20
Types of Child Restraints for Children .....	21
Additional Issues to Consider When Selecting an Appropriate Restraint .....	25
Summary of Recommendations for Selecting an Appropriate Restraint .....	26
Getting to Know Your Child Restraint: Parts of a Child Restraint .....	27
UNIT 5: HARNESSING CHILDREN CORRECTLY IN CHILD RESTRAINTS .....	31
Types of Harnesses .....	31
Proper Positioning and Harnessing of Children in Child Restraints .....	32
UNIT 6: INSTALLATION OF CHILD RESTRAINTS IN VEHICLES .....	35
Importance of Correct Installation .....	35
Reasons for Incorrect Installation .....	35
Elements of Correct Child Restraint Installation .....	35
Types of Safety Belts, Latch plates and Retractors .....	39
General Steps for Child Restraint Installation .....	42
Four Ways to Lock a Safety Belt System .....	42
Installation of Child Restraints with Lap Only Belts .....	43
Installation of Child Restraints with Lap and Shoulder Belts .....	44

Other Manual Belt Systems and Special Considerations .....	47
Installing Child Restraints with Different Types of Automatic Safety Belts .....	47
Use of Child Restraints with Air Bags .....	47
Installing Child restraints with Tethers .....	49
Installing Child restraints with LATCH .....	49
Other Vehicle Characteristics and Installation Considerations .....	51
<b>UNIT 7: CHILD RESTRAINT MISUSES .....</b>	<b>53</b>
Reasons for Misuse .....	53
Types of Misuse .....	53
<b>UNIT 8: CPS PROGRAMS, SERVICES, AND RESOURCES .....</b>	<b>55</b>
CPS Programs and Services .....	55
<b>APPENDICES .....</b>	<b>57</b>
• North Carolina and National CPS Resources	
• Summary of North Carolina Occupant Restraint Laws	
• Text of North Carolina Occupant Restraint Laws	
• North Carolina Child Passenger Safety Law: Questions Commonly Asked	
• Transportation of Children by Schools, Child Care Centers and other Organizations in NC and Homes	
• North Carolina Seat Belt Law: Questions Commonly Asked	
• Requirements of the North Carolina Children in Back of a Pickup Truck Law	
• Growing Up Buckled Up in North Carolina: Basics of NC Laws and Best Practice Recommendations	
• Buyer's Guide to Used Child Restraints	
• Recommendations for Replacement of Crash-Involved Safety Belts & Child Restraints	
• Installation of Child Safety Seats with Different Types of Seat Belts	
• Child Occupant Protection Glossary	
• English to Spanish Glossary	
• Spanish to English Glossary	
• North Carolina and National CPS Resources	

# UNIT 1: INTRODUCTION AND COURSE OBJECTIVES

## WHY ARE WE HERE?

Welcome to the North Carolina Child Passenger Safety Basic Training Program. The goal of this course is to create an awareness of the importance of child passenger safety education in preventing child passenger deaths and injuries, and to provide knowledge and hands-on practice. The student who successfully completes this course will have developed basic child passenger safety technical skills and have a minimum standard of knowledge.

Participants will be able to:

- ▶ Understand and explain state law vs. best practice
- ▶ Detect child passenger safety and seat belt law violations
- ▶ Identify resources
- ▶ Be able to say, "I don't know" when necessary
- ▶ Provide basic instruction to parents on correct child restraint use
- ▶ Assist at a child passenger safety check up clinic

Participants will **NOT** be able to:

- ▶ Serve as a Senior Checker at a Child Passenger Safety event
- ▶ Set up and coordinate a child passenger safety clinic without guidance of a Certified Technician
- ▶ Serve as a technical expert for the media
- ▶ Operate child restraint distribution program

Participants wishing to provide these community services are encouraged to pursue CPS Technician certification. Child passenger safety certification workshops are designed to teach individuals the technical and instructional skills to serve as child passenger safety resources for their organization, community or state. In general, it is recommended to take the CPS Technician certification class after working with Certified Technicians in established local programs for a period of time.

## FOCUS AND PURPOSE OF THE NC CPS BASIC AWARENESS CLASS

Although the focus of this program is primarily on child restraints designed for children under age 8, safety belt use for children and adults will be discussed. Many children small enough to benefit from child restraints are nonetheless riding in safety belts. Parents and caregivers need accurate information about the safest transition from child restraints to safety belts and the importance of buckling up themselves. Injury prevention is a family issue. Proper use of safety belts by older family members helps ensure the safety of all, particularly because many injuries occur from one passenger striking another passenger.

The information contained within this manual was current at the time of printing. Child passenger safety is a dynamic and ever changing field. New technology and product recalls are on going. The variety of safety belt systems in vehicles alone is confusing. Product recalls are

issued to correct problems not discovered during initial design and testing. We must stay abreast of changes in order to educate parents and caregivers.

The technical awareness you will develop during this awareness class is essential in order to provide correct information and assistance. You will not know everything about child passenger safety and child restraints by the end of this training program.

You will, however, know enough to help convince people to correctly use child restraints and safety belts for their children. You will know enough to recognize the limits of your knowledge and know when to say, "I don't know, but I'll find out." You will learn where to find the information you need. You will discover that many issues may not have clear, concrete solutions.

---

**Key Concept...**

The student who successfully completes this course will have developed basic child passenger safety technical skills and have a minimum standard of knowledge.

---

This program is more than the technical aspects of child restraints and safety belts. It's about children; children who are passengers in motor vehicles, children who are riding with adults that may not be aware of the dangers of a crash, children who need and deserve protection from what kills and injures too many of them.

## LIABILITY ISSUES

Please note that the following information is intended as a general overview of some liability issues that may arise. This is not intended as a substitute for legal counsel. For specific liability issues concerning your organization, consult with an attorney.

Many organizations express concerns about the extent to which they might be held liable for tort damages. This is an important concern and should not be ignored. While there is no field that can be considered liability free, there are certain precautions that can be taken which may reduce the risk of liability exposure.

We are unaware of any lawsuits filed in North Carolina against any organization pertaining to child passenger safety education, child restraint distribution or child passenger safety clinics. In a court of law, one's actions are often measured against what a reasonable and prudent person, with the same level of training, would do in a certain situation. If one performs duties that have established guidelines but fails to follow those established guidelines, that person is at great risk for liability.

Practices to follow to reduce your exposure to liability include:

- ▶ Take your training seriously and keep current by attending update sessions and specialized training on a regular basis. Always follow established state and national guidelines.

---

**Key Concept...**

Know your limitations of this and any other CPS training programs you take and learn to say, "I don't know but I will try to find out" when you don't know or the issue is unclear.

---

- ▶ Know your limitations of this and any other CPS training programs you take.
- ▶ Always be willing to say, "I don't know, but I will try to find out" when you don't know or the issue is unclear.
- ▶ Ensure that all staff involved in providing child passenger safety information are adequately trained. Follow established state and national guidelines for training and/or certification.
- ▶ Document all training activity, program content, inspection procedures, and materials distributed. Keep copies of all documentation.
- ▶ Make sure that ONLY current, accurate materials and information are distributed. Use current, dated materials from sources that are reliable in child passenger safety.
- ▶ Be cautious if you create your own promotional materials. Be sure they meet established guidelines for CPS materials and have them reviewed by specialists in the CPS field.

Ultimately, parents and other caregivers are responsible for their children's safety. Once given all the pertinent information, the parent/caregiver has the final decision and final responsibility. The parent/caregiver should always be the last one to install the child restraint and secure the child. This action should be documented. If a client, recipient, or patient disregards recommended practices, ignores manufacturer's instructions, or leaves with an unrestrained child, document the behavior.

## **OBJECTIVES OF THIS COURSE**

With this awareness level training program, participants will receive a Letter of Completion. It will not result in a formal certification.

Upon completion of this course, the participant will be able to:

1. Discuss the relevance of correct use of restraint devices in reducing injuries and deaths to children due to motor vehicle crashes.
2. Understand and explain North Carolina's occupant protection laws.
3. Describe five ways child restraint devices reduce injury to children.
4. Name eight types of child restraint devices, describing weight and height limits and appropriate use of each.
5. Demonstrate competency in correctly securing child in appropriate child restraint.
6. Demonstrate competency in properly installing child restraints in vehicles.
7. Recognize basic misuse of child restraints.
8. Recognize limitations and identify other CPS resources and programs.

Your efforts will help reduce the unnecessary and preventable motor vehicle injuries and fatalities to infants and children. Thank you for taking the time to participate in this training program.

**PREVIEW COPY**

## UNIT 2: THE NEED FOR CHILD RESTRAINTS AND NORTH CAROLINA'S OCCUPANT RESTRAINT LAWS

### THE NEED FOR CHILD RESTRAINTS

Motor vehicle crashes continue to be a leading cause of death and serious injury to children. Each year in North Carolina, about 65,000 children less than age sixteen are involved in motor vehicle crashes. On average, 80 of these children less than age five and 300 children ages 5-15 years are killed or seriously injured. Of these, most are reported to be not buckled up at all or are in improperly used child restraints or safety belts.

Children are not miniature adults. Safety belts are designed for adults and cannot adequately protect children in crashes. Children need their own special restraints because of their developmental characteristics.

Proportionately, an infant's head is larger and heavier and its legs are shorter. A newborn infant's shoulders are narrow and flexible, so they fit through the birth canal. The bones and ligaments in the neck are not well developed until after the age of one. A child's pelvis is small and rounded and its shape is not fully developed until puberty.

Child restraints work with vehicle safety belts to prevent ejection and distribute and load crash forces to the strongest parts of the body. The child restraint must be firmly attached to the vehicle and the child must be snugly secured in the child restraint in order for it to work as designed.

PREVIEW COPY

### CRASHES ARE NOT ACCIDENTS

Most injuries are not the result of "accidents". The incidents that lead to injury are often not intended, but the risk of injuries occurring in certain types of events is predictable and often preventable. Use of the word "accident" promotes the concept that these events are outside of human influence or control.

Unintentional injuries and crashes are predictable results of specific actions. We can identify their causes and take action to avoid them through injury prevention education and programs. That is why injury professionals prefer to talk about "collisions," or "crashes" rather than "accident."



### NORTH CAROLINA'S OCCUPANT RESTRAINT LAWS

North Carolina has three occupant restraint laws: the Child Passenger Safety, Seat Belt, and Children in the Back of Pickup Truck Laws. Together they cover the majority of children and adults riding in passenger motor vehicles. These laws, along with local and statewide educational and distribution programs as well as high visibility enforcement, have helped to reduce motor vehicle crash related deaths and serious injuries in North Carolina over the past

decade. The requirements, exemptions, and penalties for non-compliance for these laws are as follows:

### **North Carolina Child Passenger Safety Law: G.S. 20-137.1**

#### **Requirements**

All children less than 16 years of age must be properly restrained in all vehicle seating positions. Refer to *North Carolina Seat Belt Law* for restraint use requirements for drivers and occupants age 16 and older.

Children younger than age 8 AND who weigh less than 80 pounds must be properly secured in "child passenger restraint systems" appropriate for their weight. Most drivers will be able to comply with the changes by using belt-positioning booster seats for children over 40 pounds. Belt-positioning boosters are child restraints that are designed to raise children up to make lap and shoulder combination belts fit correctly.

When a child reaches age 8 (regardless of weight) OR 80 pounds (regardless of age), a properly fitted safety belt may be used to restrain the child. Shoulder belts behind the back or under the arm are not allowed.

If there is no lap and shoulder belt equipped seating position available for using a belt-positioning booster, a child less than 8 years of age and at least 40 pounds may be restrained by a properly fitted lap belt only. **WARNING: Belt-positioning booster seats can only be used with lap and shoulder combination safety belts. Belt-positioning booster seats must NEVER be used with just a lap belt.**

The NC CPS law requires that a child restraint (CR) be properly installed in the rear seat if the child is less than 5 years of age and less than 40 pounds in weight and the vehicle has an active passenger side air bag. The CR may be installed in the front seat if: 1) it is designed for use with air bags, 2) the vehicle has an air bag on-off switch that is turned off, 3) the vehicle has no air bag at all, or 4) the vehicle has no rear seat. Regardless of what is legal, it is strongly recommended that all children age 12 and under should ride buckled up in a rear seat in restraints appropriate for their ages and sizes.

Vehicles covered are those required by federal standards to be equipped with safety belts. This includes cars made since 1968 as well as pickup trucks, sport utility vehicles, and vans made since 1972.

No type of organization is exempt from the NC CPS Law, only types of vehicles. Child care centers, churches and other organizations using vans or other passenger vehicles to transport children are covered and must comply with all provisions of the NC CPS law. Refer to "Transportation of Children by Schools, Child Care Centers and other Organizations in NC and Homes" in the Appendix for more information.

*"Properly restrained"* means that:

- ▶ the child is within the weight range for the restraint as specified by the manufacturer,
- ▶ the child is correctly harnessed within the restraint as specified by the CR manufacturer's instructions, and

- ▶ the restraint is correctly installed in the vehicle as specified by both the CR's and the vehicle's instructions.

*"Child passenger restraint system"* means:

- ▶ Any type of child restraint (infant only, convertible, forward facing only, booster seat, harness or vest) that meets federal standards in effect at the time of its manufacture may be used. Boosters can be used for most children in the 40-80 pound range.
- ▶ A properly fitted lap belt only may be used for a child less than eight years of age and between 40 and 80 pounds if there is no lap and shoulder belt equipped seating position available for use with a belt-positioning booster seat.

### **Exemptions**

1. Ambulances or other emergency vehicles
2. When attending the child's personal needs
3. If all seating positions equipped with child passenger restraint systems or safety belts are occupied
4. Vehicles that are not required by federal law or regulation to be equipped with safety belts

### **Penalties**

1. Fine not to exceed \$25.00.
2. Full court costs apply. Cost of court is currently \$100.00.
3. Two driver's license points are assessed.
4. No insurance points can be assessed.
5. Charges are to be dropped if the child is under 8 years of age and the driver produces proof satisfactory to the court that he has subsequently acquired an approved child passenger restraint system for a vehicle in which the child is normally transported.

### **North Carolina Seat Belt Law: G.S. 20-135.2A**

#### **Requirements**

The seat belt law requires all drivers and front seat passengers ages 16 and older to have a seat belt properly fastened about his or her body at all times when the vehicle is in forward motion on a street or highway. "Properly fastened" means that the occupant is secured within the full seatbelt in the manner specified by the vehicle manufacturer's instructions.

Rear seat passengers ages 16 and older are not required to wear their safety belts. Children less than age 16 are covered under the North Carolina Child Passenger Safety (CPS) Law.

The NC Seat Belt Law applies to "passenger motor vehicles" defined as being motor vehicles with motive power designed for carrying 10 passengers or fewer, but it does not include motorcycles, motorized pedacycles, or trailers.

#### **Exemptions**

1. A driver or occupant with a medical or physical condition that prevents appropriate restraint by a safety belt or with a professionally certified mental phobia against the wearing of vehicle restraints;

2. A motor vehicle operated by a rural letter carrier of the United States Postal Service while performing duties as a rural letter carrier and a motor vehicle operated by a newspaper delivery person while actually engaged in delivery of newspapers along the person's specified route;
3. A driver or passenger frequently stopping and leaving the vehicle or delivering property from the vehicle if the speed of the vehicle between stops does not exceed 20 miles per hour;
4. Any vehicle registered and licensed as a property-carrying vehicle in accordance with G.S. 20-88, while being used for agricultural or commercial purposes; or
5. Motor vehicles not required to be equipped with seat safety belts under federal law

### ***Penalties***

1. \$25.00 fine
2. \$50.00 court costs (NOTE: Court cost for a Seat Belt law violation was set at \$50 by the NC Legislature rather than making the violator subject to the full cost of court.)
3. No driver's license points are assessed.
4. No insurance points are assessed.

### **Transporting Children in Open Bed or Cargo Area: G.S. 20-135.2B**

#### ***Requirements***

"The operator of a vehicle having an open bed or open cargo area shall insure that no child under 12 years of age is transported in the bed or cargo area of that vehicle. An open bed or open cargo area is a bed or cargo area without permanent overhead restraining construction."

"Permanent overhead restraining construction" was not specified by the legislature and has not been defined by our courts.

#### ***Exemptions***

1. If an adult is present in the bed or cargo area of the vehicle and is supervising the child;
2. If the child is secured or restrained by a seat belt manufactured in compliance with FMVSS 208, installed to support a load strength of not less than 5,000 pounds for each belt, and of a type approved by the Commissioner of the Division of Motor Vehicles;
3. If an emergency situation exists;
4. If the vehicle is being operated in a parade pursuant to a valid permit;
5. If the vehicle is being operated in an agricultural enterprise; or
6. If the vehicle is being operated in a county that has no incorporated area with a population in excess of 3,500 [Note: Counties with <3,500 population are: Alexander, Alleghany, Ashe, Avery, Bertie, Camden, Caswell, Cherokee, Clay, Currituck, Duplin, Franklin, Gates, Graham, Green, Hyde, Jackson, Jones, Macon, Madison, Mitchell, Montgomery, Northhampton, Pamlico, Pender, Perquimans, Polk, Swain, Tyrrell, Warren, Yadkin, and Yancey.]

#### ***Penalties:***

1. Fine not to exceed \$25.00
2. No court costs
3. No driver's license points are assessed.
4. No insurance points are assessed.

## LEGAL VS. BEST PRACTICE RECOMMENDATIONS

Laws are minimum standards. When we talk of what is "legal" vs. what is "recommended", we are talking about the bare minimum necessary to comply with the law vs. what is the very best to ensure your child is as safe as possible. The two biggest differences between what is legal vs. what is recommended are:

1. The NC child passenger safety, seat belt, and back of pickup truck laws are based mostly on age. However, recommendations for the best restraints to use are based on weight and physical development as well as age.
2. Any child restraint is legal to use as long as it meets federal standards in effect at the time of its manufacture. It is not recommended to use restraints that are too old or that are in poor condition or have been previously involved in a crash.
3. None of these laws require that all occupants be buckled up, all the time, in all seating positions. However, recommendations are that EVERYONE, children and adults, should ride properly restrained in all seating positions at all times.

---

### Key Concept...

Children can be transported in ways that are legal, but may not be what is best for the child. However...

Doing what is best for the child WILL be legal!

---

PREVIEW COPY

**PREVIEW COPY**

## UNIT 3: HOW RESTRAINTS PROTECT OCCUPANTS IN CRASHES

### WHAT HAPPENS IN A CRASH

It is important for child passenger safety advocates to understand basic crash dynamics. What happens in a crash? What forces do occupants and restraint systems undergo during a crash? How do safety belts and child restraints work to protect occupants. Advocates must understand these concepts before they can help parents understand how to safely transport all members of their families.

A basic law of physics states that an object in motion will remain in motion until acted on by an outside force. This means that when a car stops suddenly, all objects - including the people - inside the vehicle will continue moving at the original speed of the vehicle toward the point of impact until stopped by another object. The outside force that stops the occupant could be the steering wheel, dashboard, a tree, etc. or something designed to protect the occupants such as a safety belt or child restraint system.

---

#### Key Concept...

In a crash we WILL hit something. However, we do have a choice as to what we hit... either something dangerous or something protective.

---

The weight of the occupant times the speed the vehicle is traveling is an approximation of the force of impact an occupant will sustain in a crash. As an example, a 20 pound baby in a 40 mph crash will be thrown forward with a force of 800 pounds ( $20 \times 40 = 800$ ).

Time and distance are important variables related to crash dynamics. If we can extend the amount of time and distance it takes to stop, we can reduce the amount of force applied to the vehicle's occupants. Child restraints and safety belts, when used correctly, do indeed extend the amount of time and distance it takes the child or adult to stop.

### Three Collisions in a Crash

Even though most people think of a vehicle crash as being a single event, there are actually three collisions that occur:

1. **Vehicle collision** - The vehicle strikes tree, bridge, another vehicle, etc. The vehicle begins crushing in a controlled manner.
2. **Human collision** - The occupant strikes something in vehicle - safety belt, dashboard or steering wheel. All occupants move toward the point of impact. Other objects in vehicle strike vehicle's interior or other occupants.
3. **Internal collision** - Organs and tissues in the body strike bone or other structures. Organs can be bruised or torn in this collision.

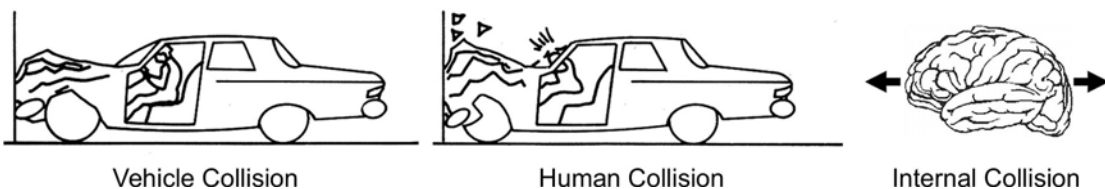

## **FOUR TYPES OF CRASHES**

There are four main types of crashes and the ways that occupants are injured tend to differ among the different types. Child restraints and safety belts help to protect occupants in all kinds of crashes.

### **Frontal Crash**

The frontal crash is the most frequent type of crash but they are not necessarily the most deadly. In any type of crash, the occupants continue to move toward the point of impact. In frontals, the occupants continue to move toward the front of the vehicle.

Any unbelted occupant can collide with another occupant or be thrown against the dashboard, windshield, or the area where an air bag deploys. Even restrained occupants can be injured if an unrestrained occupant collides with them.

### **Lateral Crash (Side Impact)**

Lateral or side impacts are considered to be the most deadly type of crash since there is less space between the striking vehicle and the occupants of the struck vehicle. Frontal crashes are twice as likely to occur as are laterals, but side impact crashes are twice as likely to result in a fatality to the occupant seated at the point of impact. There is no significant difference in the number of fatalities when seated on the right versus left side of the vehicle.

### **Rear- End Crash**

Rear-end crashes usually occur when both vehicles are moving forward or when the front vehicle is stopped. Rear-end crashes account for only a very small proportion of fatalities. In a rear-end crash, the head rotates back (unless restrained by a properly adjusted head restraint) and then is thrown forward. This results in what is called "whiplash."

### **Rollover Crash**

A rollover crash involves the vehicle rolling over onto its side or top (upside down), one time or many times. Unrestrained occupants can suffer from a wide range of injuries due to repeated contact with the vehicle's interior, such as the door and window posts, and/ or ejection or partial ejection.

### **Other Dangerous Crash Events**

Rotations (or spins) and ejections are two dangerous crash events that can occur in almost any crash or chain of crash events. In a spin, unrestrained occupants are more likely to be injured as they impact with the vehicle's interior repeatedly, and are much more likely to be ejected from the vehicle than restrained occupants.

Ejected occupants are four times more likely to be killed as those who remain inside. They are 14 times as likely to receive cervical spine injuries. People who are ejected, either totally or partially, may be thrown out a window or door, skid along the pavement, or be pinned or crushed under a vehicle. Landing gently on a soft and forgiving surface is highly unlikely. Even if the occupant does land on a forgiving surface, the vehicle itself may follow the same path as the ejected person and land on him or her.

## Occupants in Non-collisions

People can get hurt when their vehicle swerves, skids, or stops suddenly, especially if unbelted. Even in routine driving maneuvers, occupants can feel the forces of changed speed or direction, but can generally brace themselves and stay in position on the vehicle seat.

However, in emergency swerves, unrestrained drivers are more likely to lose control of their vehicle because they are not held firmly behind the wheel. Unrestrained passengers may strike one another or parts of the vehicle, causing injury. While going around a corner, an unlatched door can come open, permitting an unrestrained occupant to fall out.

## HOW RESTRAINTS PROTECT OCCUPANTS

Occupant restraint systems are designed to reduce injury to occupants and help to do so five different ways. Safety belts, air bags and child restraints are designed to:

1. **Prevent ejection** - People thrown from a vehicle are four times more likely to be killed than those who remain inside. Ejected occupants are also 14 times as likely to sustain cervical spine injury than those who remain within the vehicle.
2. **Load crash forces on the strongest parts of the body** - For an older child or adult, these parts are the hips and shoulders. For an infant and young child, there is really no part strong enough, so the restraint supports the entire body to avoid stress on any one part.
3. **Spread crash forces over a wide area of the body** - This puts less stress on any one part of the body. Lap and shoulder combination safety belts and child restraint harnesses spread the crash forces across a large area of the body. A rear-facing infant restraint spreads the force along the entire back, neck and head.
4. **Allow the body to slow down gradually** - Vehicles are engineered to crush in a controlled manner. Occupants can take advantage of the vehicle ride down only if they become a “part” of the vehicle using a snug safety belt or CRS.
5. **Protect the head, neck, and spinal column** - A shoulder belt or CRS harness helps to keep the head and upper body away from the hard interior surfaces of the vehicle. A rear facing child restraint supports the head and neck to avoid stress on the neck and trauma to the head and spinal cord.

## TYPES OF OCCUPANT RESTRAINT SYSTEMS

There is a wide range of equipment and systems that are designed to protect motor vehicle occupants in crashes. Some are “passive” or “automatic” and provide some protection to occupants without any action having to be taken by the occupant. Others, sometimes called “active” or “manual” require some action to be taken by the occupant in order to be protected. Child restraints are manual systems that will be discussed in detail in the following Units.

## Passive Occupant Protection

There are a number of passive occupant protection features that are built into the vehicles. They are not true "restraint" systems, but they do provide some protection without any action by the occupant. Such features include the padded dash, recessed control knobs, laminated windshield, roof structure, front and rear-end crumple zones, and side-impact beams. One element of passive protection that is overlooked by many people is the whiplash protection provided by head restraints. Some head restraints are built into the vehicle, others are adjustable, and most are not adjusted high enough. The middle of the occupant's head, or higher, should strike the head restraint if thrown backwards.

## Safety Belt Systems

Safety belt systems vary widely and have changed over the past 30 years. A safety belt system consists of anchor points, a latch plate, and webbing material. Many systems also include one or more retractors. The vehicle's owner's manual has specific information about the safety belt system and other occupant protection devices in that model.

There are two basic types of safety belt systems - the lap belt, and the lap and shoulder belt combination.

### Lap Belt

The lap belt is a "2-point" belt that has two anchorage points and fits over the lap (upper thighs/hips). Its primary benefits are to prevent ejection and to keep the occupant from being thrown around inside the vehicle striking other occupants or unforgiving surfaces. The lap belt does not restrain the upper body.

A lap belt should be as snug as possible and at least touching the upper thighs. In this position the crash forces will be loaded on the hips. If the lap belt is too loose, the occupant can "submarine" under the lap belt.

In a crash, seat belt syndrome occurs if a lap belt is worn over or rides up on the abdomen rather than the hipbones causing injuries to the lower spine and organs such as spleen, liver and intestines.

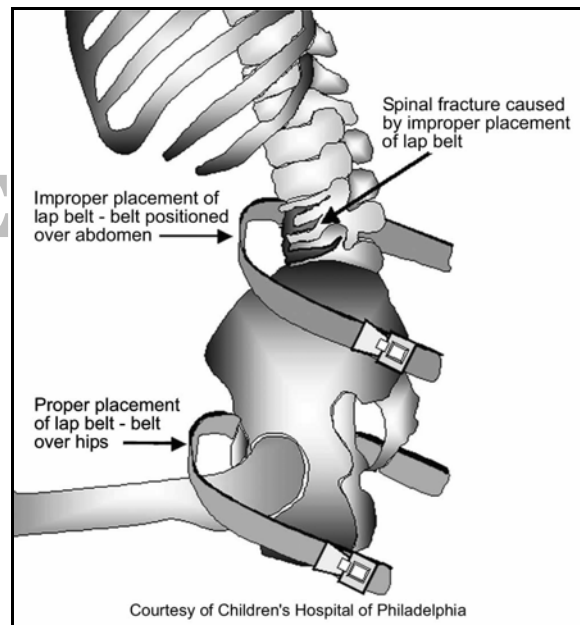

### Lap and Shoulder Combination Belt

The lap and shoulder combination belt is a "3-point" belt that has three anchorage points. The shoulder belt provides restraint for the upper chest and shoulders. When positioned correctly, the shoulder belt reduces head excursion, helping to reduce brain and spinal cord injury. The shoulder belt must lie across the collarbone as close to the neck as possible without being uncomfortable. Placing the shoulder belt under the arm or behind the back is very dangerous. Doing so increases the risk of belt-induced internal injuries in addition to not providing any upper body restraint.

The lap belt portion of a lap and shoulder combination must be positioned as mentioned above. The importance of a snugly and correctly fitted lap belt should not be neglected.

### Automatic Safety Belts

Automatic safety belts are systems designed to fit over the driver and right front passengers without them having to do anything other than close the door or start the motor. Current standards require vehicles to be equipped with air bags for the driver and right front passenger, but automatic safety belts were allowed by federal standards until 1996. There are three basic types of automatic safety belts:

---

### **Key Concept...**

- ▶ Lap belts must be worn as snugly as possible and at least touching the upper thighs.
  - ▶ Shoulder belts must come across the collar bone and middle of the chest.
  - ▶ Placing the shoulder belt under the arm or behind the back is very dangerous.
- 

There are three basic types of automatic safety belts:

1. *Shoulder belt attached to the door with knee bolster:* This type consists of a shoulder belt attached to the door with no separate lap belt. A knee bolster, the wide, curved and padded lower dashboard, restrains the lower part of the body when the knees strike it.
2. *Shoulder belt attached to the door or on a motorized track, with separate lap belt:* The manual lap belt is more effective in restraining the lower body than the knee bolster alone. The lap belt also helps to prevent ejection should the door come open. Drivers/occupants using this system must wear the manual lap belt for complete protection and to be legal.
3. *Shoulder and lap belt attached to the door:* This type is found mostly in General Motor's vehicles. Often people who have belts mounted in the door routinely buckle and unbuckle them and do not realize that the belt system is intended to stay buckled.

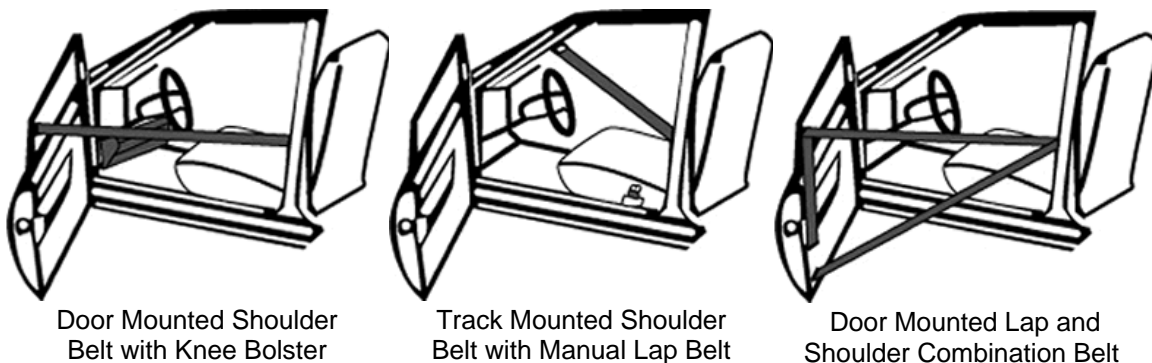

### **Air Bags**

#### Frontal Air Bags

Air bags are designed to provide supplemental head and chest protection in severe frontal crashes. When sensors in the vehicle detect a frontal crash severe enough for the air bags to be needed, the air bags inflate. When fully deployed the air bag offers additional protection to the front seat occupants. As the occupant moves into the bag it immediately deflates to further absorb energy and reduce the risk of injuries. This process is completed in approximately 1/4

of one second. Air bags supplement safety belts, they do not replace them. Safety belts are needed for protection in all types of crashes of all levels of severity.

### Side Air Bags

Side impact air bags improve the protection of adults in side impact crashes, but there are concerns that children who are leaning against a side air bag at the time of deployment can be seriously injured. Dangers to children can vary depending on the design of the specific air bag.

Side air bags vary greatly from vehicle to vehicle. Because of these variations, the best source of information is the vehicle and/or CR manufacturer. Refer to your vehicle owner's manual for recommendations that apply to your vehicle, and contact the manufacturer's customer service department with additional questions. At least one CR manufacturer states that their restraint devices must not be used in seating positions with side bags.

---

#### **Key Concept...**

Air bags are supplemental protection. Safety belts must be worn for protection in all types of crashes at all speeds.

---

## **UNSURVIVABLE CRASHES**

CPS advocates and educators must be very careful not to promise complete crash protection through the use of child restraints and safety belts. Properly used child restraints are about 70% effective in reducing fatalities and serious injuries in the smallest children. Lap and shoulder belts and frontal air bags are about 50 - 60% effective in reducing fatalities to adults.

Unfortunately, some crashes are unsurvivable despite correct restraint use. Factors that contribute to unsurvivable crashes are high speeds, small vehicle vs. large vehicle, intrusion into the vehicle, and the health and physical condition of the occupant.

---

#### **Key Concept...**

Do not promise total protection in a crash from child restraints or safety belts. Some crashes are unsurvivable despite correct restraint use.

---

## **OCCUPANT PROTECTION SYSTEMS AFTER A CRASH**

In general, safety belts, child restraints, and air bags should all be considered "one time use" products and vehicle and child restraint manufacturers recommend replacement of their restraints after a crash.

However, a child restraint may not need to be replaced following a minor crash. The National Highway Traffic Safety Administration (NHTSA) has established criteria to determine if a crash is severe enough to warrant child restraint system (CRS) replacement. According to these criteria, a crash is considered minor if ALL the following are met:

1. A visual inspection of the CRS does not reveal any cracks or deformities;
2. The vehicle with the CRS installed in it can be driven from the scene;
3. The vehicle door nearest the CRS is undamaged;

4. There were no injuries to any occupants; and
5. The air bags did not deploy

Parents who have been involved in a minor crash with their children in child restraints should call the child restraint manufacturer for advise on replacing it and continue to use the restraint in the meantime.

Insurance claims should include the cost of replacing occupant restraint systems in use in other than minor crashes. In addition, some child restraint manufacturers may offer replacement restraints for those that have been involved in a crash.

Refer to "Recommendations for Replacement of Crash-Involved Safety Belts & Child Restraints" in the Appendix for a checklist.

**PREVIEW COPY**

**PREVIEW COPY**

## UNIT 4: CHOOSING THE "BEST" CHILD RESTRAINT

### WHAT IS THE BEST CAR SEAT?

A common question parents ask is, "What is the best car seat for my child?" or "Which seat do you recommend?" There is no child restraint system that everyone agrees is "safest" or best.

All child restraints for children under 65 pounds must meet the certification requirements for Federal Motor Vehicle Safety Standard (FMVSS) 213 established by the National Highway Traffic Safety Administration (NHTSA).

FMVSS 213 requires that a child restraint's performance be measured through "crash" tests that simulate 30 mph frontal crashes into a solid barrier. This is considered to be a very severe crash. Manufacturers are required to test their child restraints using the FMVSS 213 requirements and to place labels on them with the model number and date of manufacture. If the restraint is missing the label, or if the label has no model number or date of manufacture, you should recommend not using the restraint.

---

#### Key Concept...

NHTSA sets performance standards for child restraints and the manufacturers "self certify" that their models meet these standards.

---

---

#### Key Concept...

There is no "best" child restraint. The best or safest restraint is the one that:

- ▶ Fits the child
  - ▶ Fits the vehicle and
  - ▶ Will be used correctly every ride.
  - ▶ The most expensive models are not necessarily safer than less expensive models.
- 

Since all child restraints are certified to meet federal standards and must perform to a certain level, the "best" or "safest" restraint is the one that fits the child, fits the vehicle and will be used correctly every ride. All other things being equal, the least expensive model will protect the child as well as the most expensive model.

### ARE USED CHILD RESTRAINTS OKAY?

Parents must decide if the lower cost of a used child restraint is really worth it. Many of the newer child restraints are more convenient and easier to use correctly than older models. An inexpensive but hard-to-use seat may not be a bargain over time.

In some cases, used seats can be a bargain as well as safe and easy to use. If the requirements listed below cannot be met, the best advice is to not use the restraint being considered. To tell if a used seat is safe to use, check to make sure that:

- It has a label that can be read and that clearly indicates the manufacturer, model number, date of manufacture, and that it met all applicable Federal motor vehicle safety standards in effect at the time of manufacture. If there is no label at all or if the label cannot be read, do not use the seat;

- It is no more than ten years old at the oldest. Some advocates and manufacturers suggest not using seats older than 5 or 6 years old;
- It has the instruction booklet, not just labels on the seat. (Replacement instructions can be ordered from the manufacturer);
- All the parts are included (check in the instruction booklet) or can be obtained from the manufacturer;
- It has never been used in a crash;
- It is not under recall or that corrections have been made if it was recalled.

## DEFECTS AND RECALLS

It is very important for CPS advocates and users to pay attention to recall notices and for parents to check to be sure that their restraints are safe to use. Recalls can be issued for any failure to meet Federal Motor Vehicle Safety Standard (FMVSS)

213 established and enforced by the National Highway Traffic Safety Administration (NHTSA). Problems may be discovered with child restraints during government FMVSS 213 compliance testing, through manufacturer testing, and through complaints of users.

---

### Key Concept...

Some recalls do not effect the crashworthiness of the restraint, but all recalls must be corrected to ensure safety.

---

It is important to note that many recalls or safety notifications do not effect the crashworthiness of the restraint. Many recalls are for reasons related to labeling requirements, flammability of the upholstery or padding, or for parts that pose a choking hazard. All recalls should be corrected to ensure safety. In most cases, it is better to use a recalled restraint than to not use one at all.

Owners of child restraints should register their restraint with the manufacturer so they can be notified in the event of a recall or other problems. Registration cards for older or second hand restraints can be obtained from the NHTSA Auto Safety Hotline (888-327-4236) or through the child restraint manufacturer's toll-free Customer Service number. Some child restraints can also be registered through their manufacturer's web site.

In cases where the manufacturer has gone out of business or discontinued replacement programs, the restraint should be destroyed completely and replaced. Do not throw unsafe restraints in the trash where they can be picked up and reused by others. The restraint should be destroyed by stripping the upholstery and removing the straps or by crushing the restraint.

## AFTER MARKET PRODUCTS AND SAFETY STANDARDS

There are numerous products sold for use by children in vehicles that are not regulated by motor vehicle safety standards. After market products include:

- ▶ Shoulder belt positioning devices (Most of the belt positioning devices are marketed for children who weigh over 50 or 65 pounds and, therefore, are not covered by FMVSS 213.)
- ▶ Infant head-positioning pads and head rests
- ▶ Seat saver rubber and plastic mats

- ▶ Safety belt buckle covers, and
- ▶ Toys that attach to child restraints

Many of these products make claims that they meet federal safety standards. Because there are no federal safety standards that require crash testing for these devices, the wording on the packaging is misleading. In general, CPS advocates cannot recommend the use of the products because there are no safety performance standards for these devices.

## TYPES OF CHILD RESTRAINTS FOR CHILDREN

There are many makes and models of child restraints for parents and caregivers to choose from. It is no wonder that they are confused about which type or model to use for their children. Even though there are many models to choose from, there are five basic types of child restraints. These basic types are:

1. Rear-facing only restraints
2. Convertible restraints
3. Forward-facing only restraints
4. Vehicle safety belts
5. Special needs restraints

### 1. Rear-Facing Only (Birth- up to 17-22 lbs.)

Can only be used facing the rear of the vehicle and generally the best fit for small infants. The rear facing position supports the entire head, neck and back.

They can have either a 3-point or a 5-point harness and can be used with or without a base. Most of the newer models have detachable bases that are installed in vehicle and which the restraint/carrier itself snaps into. The carrier can be easily removed to carry the infant.

Babies may outgrow this restraint in length before they reach the weight limit. The restraint should only be used until the child's head comes within an inch of the top of the shell.

Most rear-facing only restraints go up to 20 pounds but newer restraints may have an upper weight limit as high as 35 pounds. Refer to the manufacturer's instruction book for more details.

### 2. Convertible (Birth - up to 40 lbs.)

Convertible restraints can be used either rear facing or forward facing and will have weight and height limits for each position.

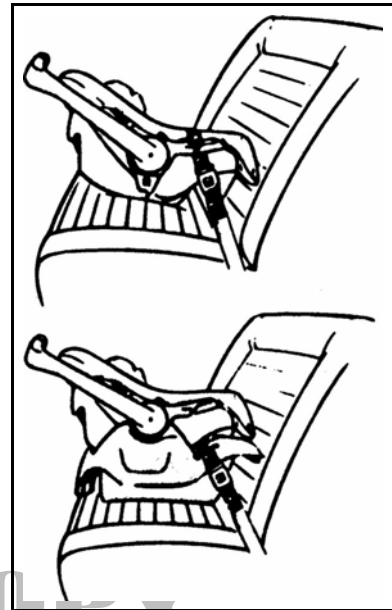

Rear-Facing Only  
With and Without a Base

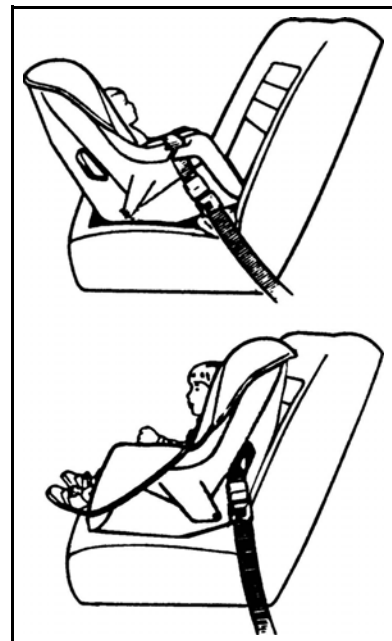

Rear- and Front-  
Facing Convertible

The upper weight limits for the rear-facing position vary from 20 - 35 pounds. Most of the newer models are approved for rear-facing use up to at least 30 pounds. This allows larger children to remain rear-facing up to at least one year old as is recommended by the American Academy of Pediatrics (AAP).

The weight limits for the forward-facing position for most models is 22-40 pounds. It is recommended that the child is not turned forward-facing until the child is at least one year old. The child will outgrow the forward-facing when the child exceeds the weight limit of the child restraint or when the top of the child's ears reach the top of the shell.

Convertible child restraints will have one of three types of harnesses: five-point harness, T-shield, or tray shield. Convertible restraints with T-shields and tray-shields are not recommended for small infants.

### **3. Forward-Facing Only (20-22 pounds up to 40+ lbs.)**

There are a variety of restraints that can only be used facing to the front of the vehicle and are recommended only for children at least a year in age AND over 20 pounds in weight.

#### ***Forward-Facing With Harness***

Some restraints are only to be used forward-facing with a harness. Most of this type have a harness limit of 40 pounds, but some may go as high as 50-80 pounds with the harness.

#### ***Booster (40 lbs.- up to 60 - 100 lbs.)***

Booster seats are for children who have outgrown a restraint with a harness but who still do not fit correctly in a safety belt. There are two types of booster seats:

##### Shield Booster:

Shield boosters were designed to use when only lap belts were available in the rear seats of most vehicles. The child sits on the booster base with a padded shield in front of the child and the safety belt is routed around the front of the shield to hold it and the child in place.

The latest models of boosters with shields that were made only allowed the shield to be used for children weighing 30-40 pounds. These models, and even some of the older ones, had a removable shield and could be used as a belt-positioning booster, if lap and shoulder belts were available.



Shield Booster



Backless Belt  
Positioning Booster

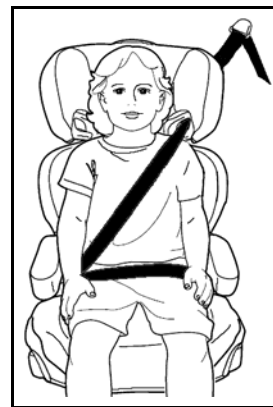

High Back Belt  
Positioning Booster

Currently, there are no circumstances where best practice recommends the use of a shield booster in a vehicle seating position that contains a lap/shoulder belt. There are no shield boosters being manufactured at this time.

**Belt-Positioning Booster:**

Belt-positioning boosters (BPB) can be used ONLY with a lap and shoulder belt. A BPB is designed to make the vehicle safety belt fit properly. Most have some type of shoulder belt adjustment. Some models have a high back; others have no back. Backless boosters should only be used in vehicles with adequate head restraint protection. High back boosters provide additional head restraint for low back vehicle seats.

**Combination Child Restraint/Booster Seat**

Combination restraints have an internal harness for children from 20 to 40 pounds and can be modified for use as a BPB. This restraint cannot be used as a BPB in a position with a lap belt only. Combination seats position the child lower and more upright than convertible seats and may not be suitable for smaller children.



Combination Restraint  
with Harness



Combination Restraint  
as Belt Positioning Booster

***Integrated (Built-In) Restraints***

Some vehicles are equipped with child restraints built into the vehicle seat. Some convert to a belt-positioning booster, while others have a five-point harness that can be used up to 40-60 pounds. The integrated seat cannot be moved from one vehicle to another.

***Shield Only (Energy Absorbing Restraint)***

The shield only uses a large shield to distribute crash forces across the torso. Some shield-only restraints are sold by vehicle dealers for use in their vehicles.

***Harness/Vest***

Travel vests have a rigid back for attachment of vehicle belt and use a 5-point harness to distribute crash forces across a child's body. Vests without tether fit children 25-40 lbs. Although they differ in appearance and function from most child restraints, they meet FMVSS 213.

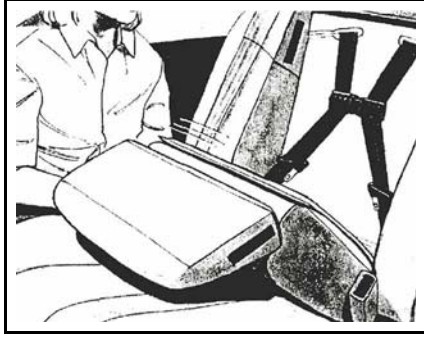

Integrated Child Restraint

E-Z-On Products manufactures many different styles and sizes of vests and harnesses that must be used with the vehicle lap belt and a top tether. They are available in a variety of sizes, some can fit adults, and are considered to be relatively inexpensive ways to provide additional upper body restraint for children over 40 pounds in lap-belt-only seating positions.

#### 4. Safety Belt

Safety belts are designed for adult occupants. Safety belts should not be used until the child can sit comfortably without slouching and knees bend over the edge of the seat. The lap and shoulder belt should fit low on the hips and across the chest and shoulder. The shoulder belt should never be placed behind the child's back or under the arm. Each child's "sitting height" and vehicle seat characteristics can vary widely and make a significant difference in how the belt fits the child.

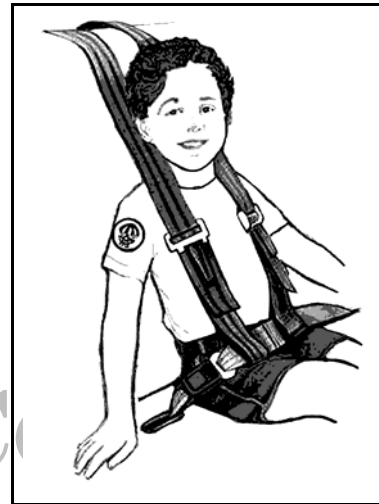

"Y" Harness with Lap Belt

*SafetyBeltSafe U.S.A.* has developed a simple "5-Step Test" to see if a child is big enough to ride in a lap and shoulder belt:

1. *Does the child sit all the way back against the auto seat?*
2. *Do the child's knees bend comfortably at the edge of the auto seat?*
3. *Does the belt cross the shoulder between the neck and arm?*
4. *Is the lap belt as low as possible, touching the thighs?*
5. *Can the child stay seated like this for the whole trip?*

*If you answered "no" to any of these questions, your child needs a booster seat to ride safely in the car.*

As a general rule, lap and shoulder belt combinations do not fit children well until they are over about 4' 9" tall. For most children, this will not be until they are about 8 years old and about 80 pounds.



Incorrect Lap and Shoulder  
Belt Fit



Correct Lap and Shoulder  
Belt Fit

As a reminder, add-on shoulder belt adjusters are not recommended, since they are not covered by any Federal standards and may, in fact, do more harm than good by pulling the lap belt up onto the abdomen in a crash.

Due to the lack of upper body restraint and increased risk of head and internal injuries, a lap belt only should be used as a last resort.

## 5. Special Needs Restraints

As a rule try to use conventional restraints for children with behavioral, medical or positioning needs. If necessary, some additional solutions are:

- ▶ **Car bed** - Premature or low birth-weight babies may have breathing problems that require them to lie flat.
- ▶ **Spelcast** - A hip spica cast spreads the legs out at a wide angle, making it difficult for children to fit into most child restraints.
- ▶ **Modified vest** - Allows children in full body cast to lie flat.
- ▶ **Positioning/postural restraints** - These restraints are used for children with poor head or trunk control and require special positioning. There are models that have been designed and tested for crash worthiness up to 100 pounds.

## ADDITIONAL ISSUES TO CONSIDER WHEN SELECTING AN APPROPRIATE RESTRAINT

### Newborns in convertible restraints:

Small infants, under 10-12 pounds, do not fit well into convertible restraints with a T-shield or tray shield. The shield is located too close to the head for optimum fit, and it holds the shoulder straps away from the body so the harness cannot fit snugly.

**Turn-around time:**

The ligaments and bones of a baby's neck are not fully developed until one year of age. If the child is riding forward facing, the head can snap forward on impact and increases the risk of serious neck injury. Encourage parents to follow the American Academy of Pediatrics March 2002 recommendation that:

“Children should face the rear of the vehicle until they are at least 1 year of age **and** weigh at least 20 pounds to decrease the risk of cervical spine injury in the event of a crash.

Infants who weigh 20 pounds before 1 year of age should ride rear facing in a convertible seat or infant seat approved for higher weights until at least 1 year of age.

If a car safety seat accommodates children rear facing to higher weights, for optimal protection, the child should remain rear facing until reaching the maximum weight for the car safety seat, as long as the top of the head is below the top of the seat back.”

**Transition from convertible/forward-facing restraint to booster seat:**

The child should stay in a restraint with a full harness until 40 pounds or more based on the manufacturer's instructions. A properly adjusted 5-point harness is considered to be the best crash protection. When the top of the child's ear is at the top of the back of the child restraint, the time has come to move into a booster seat.

Children should face the rear of the vehicle until they are at least 1 year of age **and** weigh at least 20 pounds to decrease the risk of cervical spine injury in the event of a crash. Infants who weigh 20 pounds before 1 year of age should ride rear facing in a convertible seat or infant seat approved for higher weights until at least 1 year of age. If a car safety seat accommodates children rear facing to higher weights, for optimal protection, the child should remain rear facing until reaching the maximum weight for the car safety seat, as long as the top of the head is below the top of the seat back.

**SUMMARY OF RECOMMENDATIONS FOR SELECTING AN APPROPRIATE RESTRAINT**

- ▶ Children should face the rear of the vehicle as long as possible but at least until 1 year of age **and** at least 20 pounds in weight. Infants who weigh 20 lb before 1 year of age should ride rear facing in a convertible seat or infant seat approved for higher weights until at least 1 year of age.
- ▶ Premature and small infants should not be placed in child restraints with shields, abdominal pads, or arm rests that could directly contact an infant's face or neck during an impact and injure the child.
- ▶ Children over age 1 and who weigh at least 20 pounds can be turned around to face the front of the vehicle and should ride in a properly installed front-facing convertible or forward-facing only with harness child restraint until the harness is outgrown, usually about 40 pounds.
- ▶ Children should switch to a belt-positioning booster seat only when the full harness child restraint is outgrown, usually about 40 pounds, and continue to ride in the booster seat until

the safety belt fits correctly. NC law requires the use of a booster seat or other child restraint until 8 years of age or 80 pounds, whichever comes first.

- ▶ Children should switch to a lap and shoulder belt only when both the lap and shoulder belts fit correctly. Correct safety belt fit is achieved when:
  - ▶ the child's bottom is against the back of the seat,
  - ▶ the knees bend at the edge of the seat cushion,
  - ▶ the lap belt fits low and tight across the upper thighs, and
  - ▶ the shoulder belt crosses the collar bone and center of the chest.

## **GETTING TO KNOW YOUR CHILD RESTRAINT: PARTS OF A CHILD RESTRAINT**

Although child restraints are made by many different manufacturers and come in a variety of styles, many have the same parts and features. It is important that CPS advocates and educators become familiar with all of the parts, different styles of the parts, and how they are used correctly.

### **Required Information**

#### ***Instruction Book and Storage Location***

The instruction book provides the most complete information about the restraint and how to use it correctly. Most manufacturer instruction books are located underneath or on the back of the restraint in the storage pocket.

The instruction book is one of the most important parts of a child restraint. It is impossible to know everything about every restraint. The manufacturer's instruction book must be consulted to have complete and accurate knowledge on specific products. Also, every vehicle's owner's manual includes a child restraint section, which may indicate special parts or actions that need to take place to install a child restraint.

#### ***Registration Card***

This comes with every child restraint and should be returned to the manufacturer so owners can be notified of recalls.

#### ***Labels***

Certain labels are required to be on child restraints. These are:

- ▶ FMVSS 213 certification and optional FAA certification
- ▶ Name of manufacturer, model number, and date of manufacture
- ▶ Air bag warnings
- ▶ Weight and size guidelines
- ▶ Basic installation and harnessing

### **Parts for Installing the Child Restraint**

#### ***Detachable Base***

Some rear-facing only restraints have separate bases that can be installed in the vehicle and left in place. The restraint portion can be removed from the base and installed.

### ***Recline Adjustment***

All convertible and some rear-facing only restraints have a recline adjustment. Recline angle must be considered for rear-facing restraints.

### ***Recline Adjustment Indicator***

Some convertible and rear-facing only restraints have built in indicators that allow users to tell if the child restraints are installed within their correct recline angle ranges. Indicators may be a line drawn on a label or may be an indicator with a pendulum or other moving parts fixed to the side of the child restraint.

### ***Safety Belt Path(s)***

The belt path is the manufacturer specified route through or around the frame and/or shell of the child restraint for the vehicle's safety belt. Convertible models will have at least two belt paths - one for rear-facing and one for forward-facing. Rear-facing restraints with detachable bases have different belt paths depending on whether or not the base is used. Belt path locations are labeled on the child restraint.

### ***Lower LATCH (Lower Anchors and Tethers for Children) Anchors***

Child restraints manufactured after September 1, 2002, with the exception of belt-positioning boosters, will be equipped with lower LATCH system anchors for installation in LATCH equipped vehicles.

### ***Tether Strap***

Located on the back of newer forward facing child restraints and is a required element of the LATCH system. Helps reduce the forward motion of the restraint.

### ***Locking Clip/Built-In Locking Clip***

The little metal thingy on the back of the child restraint that parents can't figure out how to use is a locking clip. Required for a tight installation on some safety belt systems. Some child restraints include special belt locking features for installation with certain types of safety belts.

### ***Shell and Frame***

The shell and frame of a child restraint provide the structural integrity needed to install the restraint in the vehicle. The shell and/or frame also work with the harness, shield, or lap and shoulder belt to secure and protect the child within the restraint. The shell is usually made of plastic. There may or may not be an internal or external metal frame.

## **Parts for Harnessing the Child in the Child Restraint**

### ***Seat Pads and Covers***

Seat pads and covers must be flame retardant and should not be replaced with any other material.

### ***Harness and/or Shield***

The harness secures the child within the shell of the restraint. The harness in a rear-facing restraint is a positioning device. In a forward-facing seat, the harness absorbs crash forces. Harness straps must be at least 1 1/2 inches wide. Harness systems may include: 3-point, 5-point, T-shield or tray-shield.

***Harness Adjustment Mechanism***

All harnesses provide some type of mechanism to adjust the length and snugness of the harness straps. Recent innovations have made some of the newer child restraints easier to adjust with the pull of a single strap from the front. Other adjustment mechanisms are less convenient and more prone to misuse, such as metal slide adjustment buckles that must be back threaded to lock the harness.

***Harness Strap Splitter Plate***

A metal plate on the back of the child restraint that attaches the two shoulder straps to the harness adjustment strap.

***Harness Slots***

There may be one to four sets of slots. It is critical that the child restraint manufacturer's instructions are referred to when determining which slots to use.

***Harness Retainer Clip***

Helps keep the harness in the proper position on the child's shoulders.

***Buckle and latch plate(s)***

The latch plates and buckle are designed to secure the harness system. Buckles are required to have a push-button release mechanism. Buckles are designed to be stiff so the child can't unbuckle them.

PREVIEW COPY

**PREVIEW COPY**

## UNIT 5: HARNESSING CHILDREN CORRECTLY IN CHILD RESTRAINTS

### TYPES OF HARNESSES

Harnesses are important because the harness keeps the child inside the vehicle, reduces contact with the vehicle interior and other occupants, distributes crash forces over the widest area of the body possible, and also loads the forces on the strongest parts of the child's body. Different harnesses have different weight limits. Check manufacturer's instructions.

Types of Harnesses found in child restraints are:

#### **Three-point Harness**

The three-point harness consists of two shoulder straps that meet and buckle in a V shape over the child. A three-point, or "V", harness holds the child in position to be protected by the semi-reclined rear-facing restraint shell. A V-harness can only be used in a rear-facing restraint.

#### **Five-point harness:**

Consists of two shoulder, two hip, and one crotch strap. Many safety experts prefer this system because the straps can be more readily adjusted to fit a variety of shapes and sizes of children correctly and snugly. However, many of the 5-point harness straps tend to get twisted over time.

#### **T-shield:**

The shoulder straps are attached to a flat padded T-shaped shield with the bottom of the "T" buckling into the base of the seat. The T-shield serves as the hip and crotch straps. T-shields are not recommended for very small infants.

#### **Tray-shield:**

The shoulder straps of the tray shield are attached to a wide, padded shield. The shield is connected to the shell of the restraint by rigid arms and swings up and down over the child. The big padded bar looks safer to some parents, but in fact it is no safer than a five-point harness or T-shield. In addition, tray shields tend to be difficult to adjust and difficult to use in small vehicles where the shield may not swing all the way up. Tray-shields are not recommended for very small infants.

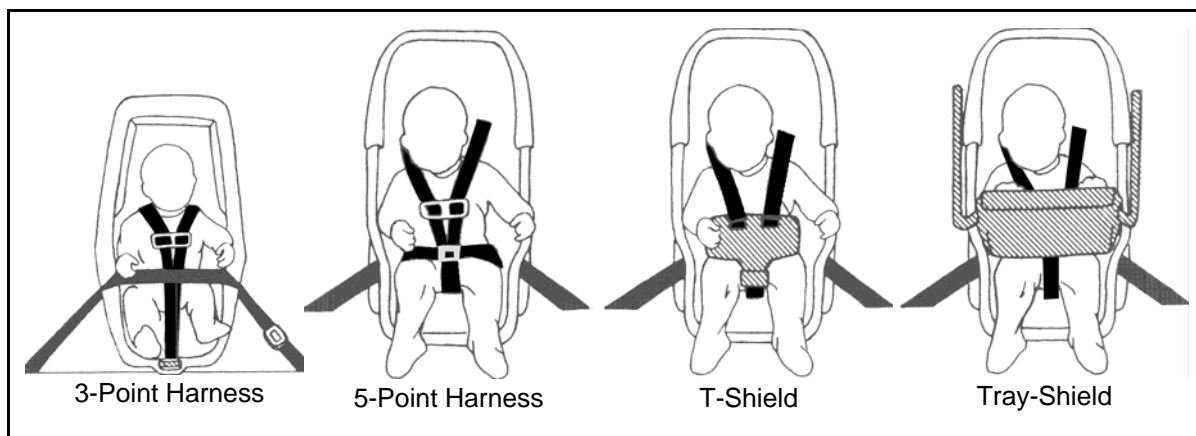

### **Shield Only**

Some models of restraints use just a shield or some type of broad and curved surface to hold the child in the restraint and to distribute and absorb crash energy. Some are sold by European vehicle manufacturers for use in their vehicles and are available only through their dealers.

## **PROPER POSITIONING AND HARNESSING OF CHILDREN IN CHILD RESTRAINTS**

### **Securing The Harness For Rear-Facing Infant And Convertible Child Restraints**

Always check manufacturer's instructions. In general the shoulder straps should be at or below the rear-facing infant's shoulders (or in the lowest slot).

Check to ensure buckle is latched completely. A harness must be snug enough not to leave any slack, but should not be so tight as to press into the child's body. Position the harness retainer clip at armpit level to keep the straps on the child's shoulders.

If needed, place a rolled diaper or small blanket in front of the crotch strap between the child's legs to prevent slumping.

The semi-reclined rear-facing position provides the primary crash protection. The harness serves to correctly position the child and to prevent ejection. The recline angle, ranging from 30 - 45 degrees, needs to be upright enough to provide crash protection but not so upright that the child's head falls forward toward the chest. Older children are better able to tolerate a more upright position.

### **Securing the Harness for Forward-Facing Child Restraints**

The child restraint should be in an upright position and harness straps threaded as specified by manufacturer. For most models the harness straps must be in the upper slots. The lower slots may not be strong enough to withstand forward-facing crash forces.

Move the crotch strap, if adjustable, to properly align the harness over the hips. Snug the harness and check to see that the harness retainer clip is at armpit level. Loose straps allow excess forward movement of the child and make it easier for the child to wiggle out of the harness.

### **Adjusting the Harness**

Different models have different methods for harness adjustment. Harnesses on a few older models of child restraints use retractors to take slack out of the harness and to lock the harness in place during a crash, but most require some type of manual adjustment. Be sure to read the manufacturer's instructions to be certain of the proper way to position and adjust the harnesses. Harness adjustment mechanisms include:

#### ***Slide adjustment buckle***

The metal slide adjustment buckle must be back-threaded to prevent loosening of the harness. The buckle may be located at the bottom of the frame or behind the seat. Look for buckles hidden in storage compartments on infant seats. These buckles can be inconvenient and prone to misuse.

**A-Locks**

Adjustable devices on the front of many restraints. This harness is easy and convenient to use. Pull one strap to tighten, release lever to loosen. Variations, such as "Twist a Turn" on some models.

**Rod and slot systems**

A rod is inserted in appropriate fabric loops at the end of the harness.

**Twist-Knobs**

The harness tightens or loosens as a knob or dial is twisted to wind or unwind the excess harness onto or from a spool.

PREVIEW COPY

**PREVIEW COPY**

## UNIT 6: INSTALLATION OF CHILD RESTRAINTS IN VEHICLES

### IMPORTANCE OF CORRECT INSTALLATION

Installing the child restraint securely in the vehicle is the third step in the three-part process of correct use.

Child restraints are designed to be anchored to the vehicle with a very tight lap belt or lap portion of a lap/shoulder belt. Some types of belt systems do not stay snug during normal driving. Safety belts that do not stay tight around child restraints in normal driving will lock in a crash but will lock with slack in the system. The child restraint could be knocked over or out of position during braking or in other maneuvers before the belt locks.

### REASONS FOR INCORRECT INSTALLATION

There are many reasons child restraints are installed incorrectly:

- ▶ Failure to read instructions
- ▶ Lack of instructions
- ▶ Confusing instructions
- ▶ Child restraint and vehicle incompatibilities

### ELEMENTS OF CORRECT CHILD RESTRAINT INSTALLATION

There are five basic elements that must be considered when installing a child restraint. The child restraint must be installed:

1. In the correct orientation (forward versus rear facing).
2. With the recommended recline angle.
3. In the safest possible position in the vehicle.
4. Using the correct belt path or LATCH anchors.
5. With a tight and locked seatbelt or LATCH system.

#### 1. Correct Forward- or Rear-Facing Orientation Of the Child Restraint

Children should face the rear of the vehicle until they are at least 1 year of age and weigh at least 20 pounds. If a child restraint accommodates children rear-facing to higher weights, for optimal protection, the child should remain rear facing until reaching the maximum weight for the child restraint, as long as the top of the head is below the top of the restraint back. This recommendation is based on policy statements of the American Academy of Pediatrics.

---

#### Key Concept...

Children should face the rear of the vehicle until they are at least 1 year of age and weigh at least 20 pounds.

---

Most rear-facing only restraints with carrying handles require that the handles be down when installed in the vehicle, but there are exceptions. Refer to the child restraint instructions to be sure.

## 2. Correct Recline Angle

The child restraint manufacturers' specified recline angle, generally ranging from 30 to 45 degrees from vertical, provides the appropriate compromise between the amount of recline needed to maintain an open airway for the infant while being upright enough to provide maximum crash protection. However, the recline angle cannot be more or less than allowed by the manufacturer. Always consult the manufacturer's instructions to determine the appropriate recline angle range for any given model.

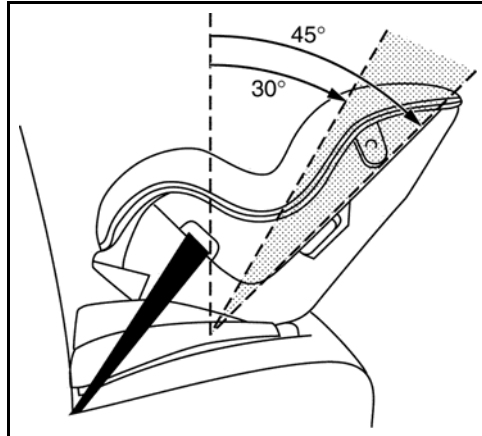

Many models of rear-facing child restraints have some type of correct recline indicator. As long as they are in good condition, recline indicators should be used to help install the restraint at the correct angle. It is important to recognize that some recline indicators will give false readings if the pavement the vehicle is parked on is not level. Identifying the correct recline angle by "eyeballing" the child restraint recline angle in relation to horizontal surface such as the floorboard is sometimes necessary.

Sometimes it is difficult to install a rear-facing child restraint with the appropriate recline angle on a steeply sloped vehicle seat. The "fix" for this situation that has been crash tested is to place a tightly rolled blanket, towel, newspaper, or foam "pool noodle" at the vehicle seat bight and then position the child restraint on the rolled object. The limit to the size of the rolled object/noodle used is determined by achieving an appropriate recline angle. Whatever material is used should be as incompressible as possible.

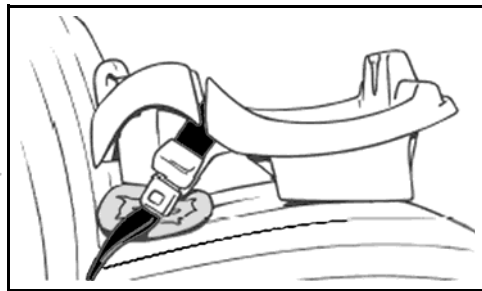

Some models of rear-facing only child restraints with detachable bases have levers or some type of adjustable "foot" intended to circumvent the need for rolled towels or noodles. For most child restraint models with these adjusters, either the adjustable foot or a noodle, but not both, can be used to position the child restraint at the correct recline angle.

---

### Key Concept...

The rear-facing child restraint should be reclined far enough so that the infant's head touches the back of the restraint and does not flop forward. However, the recline angle cannot be more or less than allowed by the manufacturer.

---

Some models of child restraints have front-facing recline positions also. Child restraints must pass the required crash tests in all manufacturer-designated positions. Designated front-facing recline positions, intended to allow the front-facing child to sleep easier, are acceptable to use. As a practical matter, these recline positions may not be needed since most models of CR's recline enough to allow sleeping after being installed in the most upright position.

### **3. Safest Position In Vehicle:**

The general considerations that come into play for determining the safest position in a vehicle for installation of a child restraint include:

- ▶ Should the child restraint be installed in the front or back seat?
- ▶ Are there any active air bags in that seating position?
- ▶ Can the safety belt or LATCH system be used to properly install the child restraint?
- ▶ Are there any other features, such as vehicle seat contours, rigid buckle stems, anchor locations, limited interior compartment space, or fold down armrests, that may cause a problem?
- ▶ How do the needs of each occupant relate to the needs of all other occupants?

#### ***Front seat or back seat?***

In general, the back seat is safer. The center of the rear/second seat of a motor vehicle is usually the safest, being farthest from the point of impact from any direction.

The center position is not always the optimal position for installation of a child restraint. Instances when the center rear might not be best include:

- ▶ There is no center seating position.
- ▶ The safety belt in that position for some reason does not work well to install the child restraint.
- ▶ If a pull-down armrest or console is present, some child restraint instructions will prohibit rear-facing installation in that position.
- ▶ If the vehicle manufacturer prohibits installation of child restraints in that position.

There are other situations in which placing a child in the rear seat is not possible or may not be as safe as some alternatives. Examples of situations where placing a child in the front seat may be necessary include:

- ▶ Families with more children than rear seating positions.
- ▶ Rear seats with lap only belts and older children who need lap and shoulder belts.
- ▶ Rear seat too narrow to accommodate a child restraint.
- ▶ No rear seat.

#### ***Is there a passenger air bag in the vehicle?***

NEVER place a rear-facing child restraint in front of an active air bag. Research has clearly shown that inflating air bags cause serious or fatal injuries to rear-facing infants and other improperly restrained occupants.

The basic and simple message that parents and other caregivers need to keep in mind is that children ages 12 and under should ride in the back seat. If children must regularly sit in the front because the vehicle has no rear seat or there are too many children for all to ride in the back, the air bag should be turned off. There is a procedure through NHTSA where an air bag ON/OFF switch can be installed.

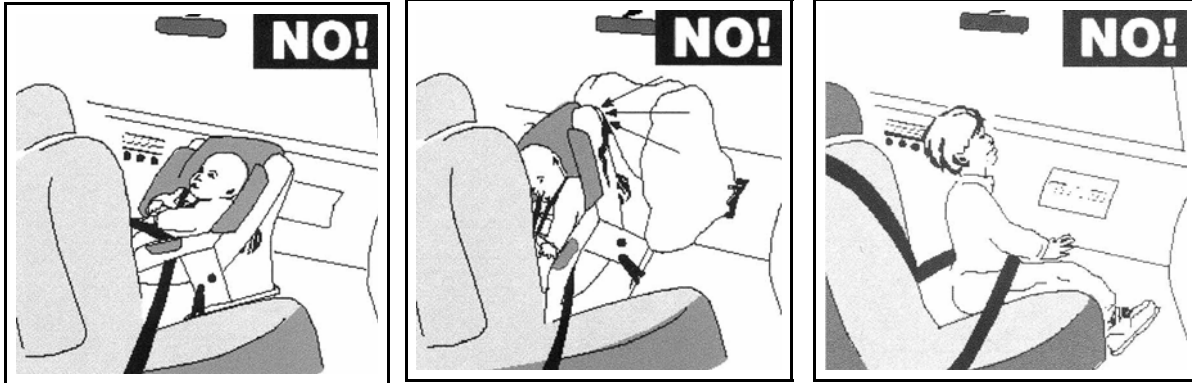

If children must sit in the front seat, they must be properly restrained with upper and lower body protection. This means using a lap and shoulder belt, a lap and shoulder belt with a belt positioning booster or forward facing child restraint with an internal harness. The vehicle seat should be moved back far enough to give at least 10 - 12 inches between the child's head or chest and the air bag compartment.

Behavioral, as well as physical, maturity must also be considered since anyone sitting in front of an active air bag needs to remain seated with proper posture and positioning rather than leaning up or otherwise moving out of position.

***Which type of safety belt system is present?***

Not all safety belt systems can be used to properly install child restraints. Some belt systems are so difficult to use that parents should avoid them and consider another seating position. Tether anchor locations and lower LATCH anchors will also impact the choice of safest seating position.

***Are there any features present in any of the positions that will make installation of a child restraint easier or more difficult?***

- ▶ The contours of the vehicle seat, such as deep "buckets" or large humps may make it difficult to find a child restraint that will fit.
- ▶ Child restraints are not compatible with side facing jump seats.
- ▶ At least 80% of the child restraint base must be supported by the vehicle seat cushion. No more than 20% can hang over the edge of the cushion.
- ▶ The width of the child restraint belt path should be no greater than the width between the safety belt anchor points.

***How do the needs of each child relate to the needs of other children or adult occupants?***

All attempts should be made to choose a seating position that will give all occupants the best protection possible. An example of this would be to install a forward facing convertible seat in a center lap-belt-only position to leave the outboard lap and shoulder belt positions available for a child's older, larger siblings or an adult. Sometimes "real world" conditions lead to choices that are less than ideal, that do not follow strict "best practice" guidelines. Ultimately, it is the parents who should make the final decision as to who is positioned where in the vehicle.

#### **4. The child restraint must be installed using the correct belt path or LATCH anchors.**

Child restraints are designed by engineers to provide crash protection when installed in a vehicle. The restraints are engineered and tested with one or more designated safety belt routing paths around and/or through their frames or shells. Failure to follow the manufacturer's installation instructions will reduce the effectiveness of the child restraint and can even lead to catastrophic failure of the child restraint in a crash.

#### **5. Tight and locked safety belt or LATCH system.**

Many CR's are too loose because some parents do not understand the importance of a tight installation. Many parents who mistakenly grab the properly installed rear-facing child restraint near the baby's head (instead of near the belt path) think the child restraint is not installed securely because it moves up and rearward or wiggles side to side at the top.

---

#### **Key Concept...**

The parent/caregiver must be able to reproduce an installation and should be able to do so without using brute force.

---

How tight is tight enough? Child restraints should be installed so that there is no more than one inch of movement front to back and side to side when tested at the belt path. A secure installation can be achieved without causing damage to the vehicle or child restraint and without using brute force.

### **TYPES OF SAFETY BELTS, LATCH PLATES AND RETRACTORS**

#### **Lap Belt**

A lap belt, sometimes called a "2-point" belt, has two anchorage points and fits over the lap (upper thighs/hips) of the occupant. The primary function of the lap belt is to hold the occupant in the vehicle. It may require manual adjustment or be adjusted by a retractor.

If a lap belt rides up onto abdomen, it may contribute to serious abdominal and spinal injury. This type of belt is the least desirable type of safety belt because it does not provide upper body restraint. Lap belts have been required in passenger cars since 1965.

#### **Lap and Shoulder Belt**

A lap and shoulder combination belt is a "3-point" belt, i.e., it has three anchorage points and contacts the body across the shoulder and across the upper thighs/hips. The shoulder belt provides additional restraint for the upper body and helps reduce head excursion.

Some of these belt systems are manufactured as one long continuous piece of belt webbing and others are comprised of two separate pieces of webbing. Shoulder belts have been required in front seats since 1973. Rear outboard shoulder belts have been required since 1989.

The importance of correct fit of the lap part of a 3-point belt is often neglected. Be sure users know to pull the lap part of the belt tight and push it down low on the hips.

## Parts of a Safety Belt

**Webbing:** The fabric of the belt, which secures the occupant to the vehicle during a crash and extends the time that the deceleration forces are experienced by the occupant, allowing the occupant to “ride down” the crash.

**Anchor points:** Where the safety belt is attached to the vehicle frame or to the seat itself.

**Latch plate:** The metal “tongue” attached to one side of the webbing.

**Buckle:** The receptacle that comes out from the “bight” in the back of the seat, a slot in the seat cushion, or from the side. The latch plate inserts into the buckle.

**Seat “bight”:** The intersection between the bottom vehicle seat cushion and the back cushion (the seat crack).

**Retractor:** A retractor is a device that winds up the loose webbing of the unused safety belt. Retractors are usually located out of sight at an anchor point. The retractor takes up the slack and provides slight tension on belts that are in use.

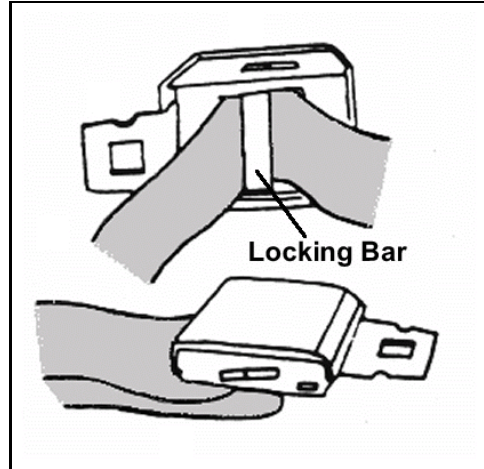

Locking Latch Plate

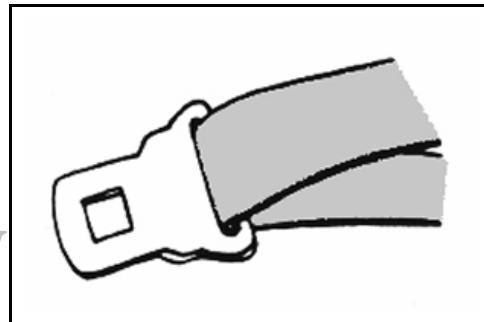

Sliding Latch Plate

## Types of Latch Plates

The different types of latch plates that can be found in cars, trucks and vans include locking, sliding, and fixed.

### **Locking Latch Plate**

#### **Standard Locking Latch Plate**

The locking latch plate is the original type and requires manual adjustment. The webbing threads through an adjuster in the latch plate. Once buckled, the belt is tightened by pulling on the extra webbing (the “tail”) of the lap belt or the shoulder portion on the lap and shoulder belt. A locking bar or adjuster inside the latch plate will not allow the webbing to slide back through the latch plate as long as the proper belt angle is maintained.

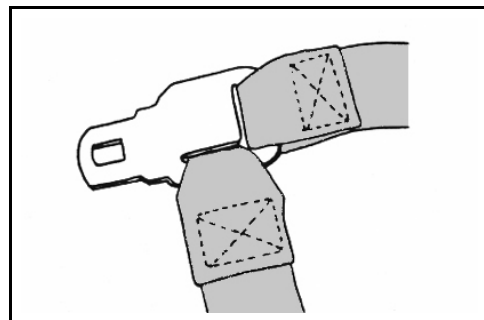

Sewn Latch Plate

#### **Lightweight Locking Latch Plate**

Looks different than standard locking latch plate but still has moving parts. Some lightweight locking latch plates “cinch” the webbing and may not keep the lap portion of the belt from

loosening when enough pressure is applied. These latch plates are common in vehicles made since 1995 when federal standards were amended to make correct installation of CRSs easier.

### ***Sliding Latch Plate***

Belt systems that use sliding latch plates have one long piece of webbing and are called “continuous loop” belts. The webbing is threaded through a slot in the latch plate and there is no locking bar. The latch plate slides freely along the webbing, whether or not the belt is buckled, or webbing is parallel to the latch plate. This type of latch plate is found only on lap-and-shoulder belts. It relies on the retractor for locking the belt tightly during a crash or sudden stop.

### ***Switchable Latch Plate***

The switchable latch plate is one that is normally a sliding latch plate that can be switched to lock and hold the lap belt webbing at a fixed length by sliding a button or turning a dial to the “child” position.

### ***Sewn-on (fixed) Latch Plate***

The sewn-on latch plate is permanently attached to the webbing and cannot be adjusted at this point. They can be found on both lap-only and lap-and-shoulder belts. One or more retractors provide for the adjustment and locking of the belt.

## **Types of Retractors**

### ***Belts With No Retractor***

Many center rear safety belts have no retractor. Instead, the belt webbing is fixed to the anchor points and is manually adjusted with a locking latch plate.

### ***Automatic Locking Retractor (ALR)***

An ALR locks in place after being pulled out and allowed to retract about ½". The belt can not be extended unless it is first fully rewound. The ALR was the original type of retractor used in cars but was uncomfortable for adults. Their tendency to “cinch-down” on occupants is led to the design of the more comfortable emergency locking retractor.

### ***Emergency Locking Retractor (ELR)***

An ELR allows the belt webbing to be freely extended or rewound. It locks only when the vehicle slows, changes direction, or stops suddenly. Some systems also lock if the occupant moves suddenly for any reason.

All ELR's are vehicle sensitive, that is, they lock in direct response to the vehicle's deceleration or sudden movement. ELR locking mechanisms use pendulums or ball-in-cup devices that move - and engage the lock - in response to vehicle motion. Some ELR's are also webbing or belt-sensitive ELR's that temporarily lock in response to a quick jerk or pull on the belt. When the tug is relaxed, the device disengages and allows the belt to move freely.

ELRs with webbing-sensitive locking mechanisms are sometimes mistaken for an ALR by “overzealous” belt checkers! Checking for retractor type requires slow, gentle movement.

### ***Switchable Retractor***

Switchable retractors can be manually adjusted from ELR to ALR. For most, the webbing is pulled all the way out of retractor to activate the ALR. Most switchable retractors have a label

on the belt with instructions on how to switch it. In some models, the retractors switch from ELR to ALR with the push of a button.

## GENERAL STEPS FOR CHILD RESTRAINT INSTALLATION

Even though there are many different types of child restraints and many different types of safety belt systems used to install them, there are common steps that need to be followed to insure a correct installation:

1. Place the CR on the vehicle seat in the proper forward- or rear-facing orientation and at the correct angle.
2. Place the safety belt through the correct belt path and then buckle.
3. Push the CR down into the vehicle seat cushion. Use an arm, forearm or knee to use some body weight to help with this. Be especially careful where you push when installing a rear-facing seat with the infant already in it.
4. Tighten and lock the belt.
5. Pull on the CR at or near the belt path. There should be no more than 1" of side-to-side or front-to-back movement.
6. Tug on the lap portion of the safety belt to be sure that it will stay locked and tight.
7. Check CR installation for tightness before each use.

## FOUR WAYS TO LOCK A SAFETY BELT SYSTEM

The manner in which a safety belt locks effects the ease with which it can be used for installing a child restraint. There are four ways to lock a belt system:

1. At the latch plate
2. At the retractor
3. Locking clip (A locking clip must be used on lap and shoulder combination belts that do not lock at either the latch plate or retractor. This is a fairly common "fix" with cars made before 1996)
4. Belt shortening clip (Belt shortening clips must be used on lap only belts that do not lock at either the latch plate or retractor. This "fix" is rarely needed.)

**IMPORTANT NOTE:** Child restraints installed with a LATCH system do not use the safety belt.

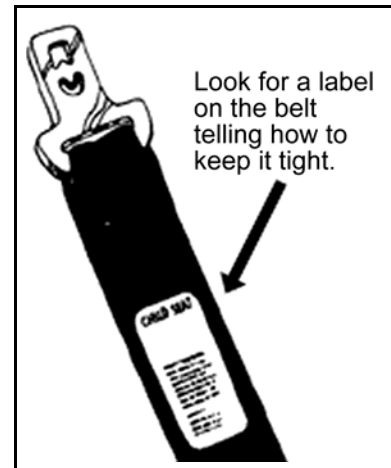

Once a CPS advocate helps a parent or caregiver with the installation of a child restraint, the parent(s) should be able to reproduce the secure installation. Parents should be able to achieve a tight fit without superhuman effort! In some cases it helps to have a second person to assist.

Note also that a chart “Installation of Child Safety Seats with Different Types of Seat Belts” can be found in the Appendix.

## **INSTALLATION OF CHILD RESTRAINTS WITH LAP ONLY BELTS**

Remember that every time that you install a child restraint with a lap only seatbelt, the system must be tightened and then locked at either the latch plate or retractor. Locking clips cannot be used on lap only belts.

### **Lap Belts That Lock at the Latch Plate**

#### ***Manually Adjusting with Locking Latch Plate***

The manually adjusting lap belt works well for installing child restraints (except BPB) in most cases. Manually adjusting lap belts use a locking latch plate to keep the belt webbing tight. Once tightened, the belt will not loosen until it is unbuckled or the latch plate is tilted.

To install a child restraint with a manually adjusting lap belt, route the safety belt through the correct belt path on the child restraint and buckle it. Push down on the child restraint while pulling on the loose end of the belt to tighten it. Check to be sure that the latch plate and webbing are parallel. If the safety belt loosens due to latch plate angle, unbuckle the belt, flip the latch plate over one-half turn, and re-buckle.

If this does not work to keep the belt tight, twist the webbing on the buckle portion once or twice to shorten it. This places the latch plate and buckle lower and away from the child restraint belt path. However, twisting the webbing reduces its strength and should only be done as a last resort. The decision "to twist or not to twist" should be made by the parent/caregiver after consulting the vehicle owner's manual.

Do not use a locking clip with a manually adjusting lap belt. The locking clip can only be used on a continuous loop lap/shoulder belt combination, discussed later.

### **Lap Belts That Lock at the Retractor**

#### ***Automatic Locking Retractor (ALR) with Fixed Latch Plate***

Lap belts with automatic locking retractors (ALR's) work well for installing child restraints. The locking mechanism is in the retractor. It locks when the belt webbing is pulled out of the retractor and is allowed to rewind back into the retractor about an inch. When the ALR locks, an audible click of the locking mechanism can usually be heard. An automatic locking retractor stays locked and tight around the occupant or the child restraint until it is unbuckled and allowed to fully retract.

When using an automatic locking retractor to install a child restraint, route the belt through the correct belt path on the child restraint and buckle. Then push the child restraint down into the vehicle seat cushion while feeding any slack back into the retractor. The retractor continues to lock as the belt tightens.

**WARNING:** Check to make sure the belt stays locked before and after the child is harnessed in the seat. Short belt paths (some shield boosters or infant bases) can allow the belt webbing to wind back to the point that it unlocks. If this occurs, try another seating position or contact a certified technician for instructions on how to install the seat.

### ***Switchable (Combination ALR and ELR) Retractor with Fixed Latch Plate***

A switchable retractor belt moves freely in and out of the retractor and locks as an emergency locking retractor (ELR) during routine driving. This feature provides the comfort of an ELR. Then, it switches to an automatic locking retractor (ALR) to install a child restraint. Thus, a switchable retractor provides the comfort of an ELR for adults but also has the lockability of an ALR for installing child restraints.

Most switchable retractors convert from ELR to ALR when the belt webbing is fully extended to engage the ALR. The retractor converts to ALR at this point (sometimes a clicking sound is heard). A few may convert by flipping a switch on the retractor (check the vehicle owner's manual and look for labels on the belt).

To install a child restraint with an ELR/ALR switchable retractor, route the safety belt through the correct belt routing path for the child restraint and buckle the belt. Switch the retractor to the locking (ALR) mode, tighten and feed excess slack back into retractor. Be sure to check that the safety belt locks and stays in the ALR mode.

### **Lap Belts That Need a Special "Fix"**

#### ***Emergency Locking Retractor (ELR) with Sewn-on Latch plate***

An emergency locking retractor (ELR) does not lock during normal driving. Instead, the ELR remains adjustable (the webbing can freely move in and out of the retractor) to give the adult driver or occupant comfort and convenience.

Because of this design, an ELR will loosen during normal driving and not remain tight around the child restraint. "Vehicle sensitive" locking of the retractor occurs when sudden movement of the vehicle causes a pendulum to swing and lock the retractor. All ELR systems are vehicle sensitive. Some ELR retractors also lock when there is sudden movement of the belt webbing itself, such as when your body is thrown against the belt in a crash or when you tug on it sharply.

The problem with this type of safety belt is that the retractor will lock in a crash, but the belt will be too loose to provide good protection in the crash. EMERGENCY LOCKING RETRACTOR LAP BELTS CANNOT BE USED FOR INSTALLING CHILD RESTRAINTS WITHOUT A BELT SHORTENING CLIP, obtained from a vehicle manufacturer. Refer to a certified technician. The easiest solution to this problem is to install the child restraint in another seating position if possible.

## **INSTALLATION OF CHILD RESTRAINTS WITH LAP AND SHOULDER BELTS**

Whether or not a lap and shoulder belt can be used to correctly install a child restraint depends on if the lap belt portion of the system can be shortened and locked tight enough to secure the child restraint tightly. As long as the lap belt part of the system is tight enough and locked, it does not matter if the shoulder belt is loose.

Remember that the system must be locked by either the latch plate, by the retractor, or by using a locking clip.

## **Systems That Lock at the Latch Plate**

### ***Continuous Loop Lap and Shoulder Belt with Locking Latch Plate***

The lap belt of this system will stay tight as long as the latch plate and lap belt webbing are parallel. Some locking latch plates are lightweight and may or may not work well to install a child restraint. The lightweight latch plate may only "cinch" rather than lock and release when enough pressure is applied to the belt webbing.

To install a child restraint with a continuous loop lap and shoulder belt with a locking latch plate, thread the lap belt through the correct belt routing location and buckle it (usually, the shoulder belt portion will follow the lap belt) and then pull on the shoulder belt to tighten the lap belt. Do this while pushing the child restraint into the seat cushion. After installing the child restraint, check to see that the lap portion of the belt will not loosen over time by gently pushing and pulling the child restraint from side to side to simulate normal driving conditions. If the belt loosens, flip the latch plate one half turn, add a locking clip, or shorten the buckle by twisting the webbing.

### ***Continuous Loop Lap Shoulder Belt with Switchable Latch Plate***

Some vehicles are equipped with continuous loop belts with an ELR retractor on the shoulder belt and a latch plate that is equipped with a switch to convert it from free-sliding to locking. It is more common in foreign vehicles. There is usually a small button or switch on the back of the latch plate to switch it to the locked position.

In order to use a continuous loop lap shoulder belt with switchable latch plate to install a child restraint, switch the latch plate to the locking mode, and install the child restraint as if it were a standard locking latch plate.

## **Systems That Lock at the Retractor**

### ***Continuous Loop Lap Shoulder Belt with Free-sliding Latch Plate and Switchable Retractor***

Some manufacturers equip their lap and shoulder belts with sliding latch plates and switchable retractors. Most of these systems switch from ELR to ALR when the shoulder belt is fully extended. A few switchable systems convert by flipping a switch on the retractor (check the owner's manual).

In order to use a continuous loop lap shoulder belt with free-sliding latch plate and switchable retractor to install a child restraint, route the safety belt through the correct belt path and buckle, slowly pull the belt webbing all of the way out of the retractor to switch the retractor to its ALR mode, allow the retractor to take up most of the slack in the belt, and then pull on the shoulder belt to tighten the lap belt while feeding the slack back into the retractor.

**WARNING:** Check to see that the belt stays locked in the ALR mode. Short belt paths (some shield boosters or infant bases) can allow the belt webbing to wind back to the point that it switches back to the ELR again. If this occurs, use a locking clip or try another seating position.

Note also that sometimes the tension on the shoulder belt will pull so hard on the child restraint that it tilts the child restraint to the side and off of the cushion on one side. If this happens, reinstall with less tension and see if it stays tight enough without tilting. You may need to leave the retractor in ELR mode and use a locking clip.

## Systems That Need a Special “Fix”

### **Continuous Loop Lap and Shoulder Belt with Free-sliding Latch Plate and ELR Retractor**

With this system, the belt webbing is threaded through a slot in latch plate so that the webbing slides freely through latch plate even when buckled. The sliding latch plate depends on a retractor at the shoulder end of the webbing to lock the belt system. The lap belt length cannot be kept short enough to hold a child restraint securely without the addition of a locking clip to hold the belt tight. This is the **ONLY** purpose for the locking clip supplied with child restraint.

Locking clips come with all new child restraints and instructions for their use are included with the child restraint instructions.

In order to use a continuous loop lap and shoulder belt with free-sliding latch-plate and ELR retractor to install a child restraint, route the safety belt through the correct belt path and buckle. To install the locking clip:

1. Pull on the shoulder belt to tighten the lap belt while pushing the CR down into the seat cushion.
2. Grasp both the lap and shoulder portions of webbing directly behind the latch plate and hold them together.
3. Unbuckle the safety belt.
4. Place the locking clip on the safety belt webbing as close to the latch plate as possible and within 1 inch.
5. Re-buckle the safety belt and test to see that it is tight. It should be somewhat difficult to re-buckle if the safety belt is made tight enough.
6. If the locking clip binds against the edge of the frame or shell of the CR and it cannot be moved closer to the latch plate, move the clip so that it rests just inside the frame or shell.
7. Remove the locking clip when the safety belt is used for another occupant.

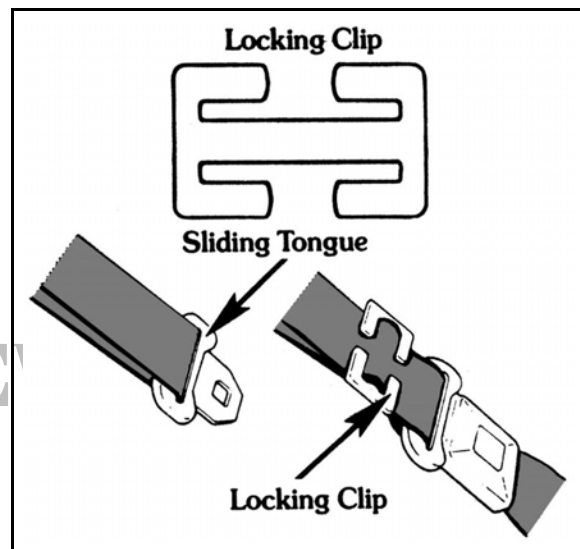

**WARNING:** Locking clips must **NOT** be used on the side of the child restraint near the retractor. When the locking clip is placed incorrectly it is likely to release from the belt and becomes a dangerous projectile. This creates slack in the belt and will allow excessive movement of the child restraint.

**NOTE:** Some child restraints are equipped with built in locking clips (sometimes called lock-offs). Built in locking clips work as well as standard locking clips and are easier to use.

## **OTHER MANUAL BELT SYSTEMS AND SPECIAL CONSIDERATIONS**

### **Separate Lap and Shoulder Belts**

These lap and shoulder belt systems consist of two separate pieces of webbing with two sets of buckles. Each belt must be buckled separately or the latch plates must be interlocked with each other before buckling. These systems are found in older vehicles and may or may not be suitable for installing child restraints.

To use separate lap and shoulder belts to install a child restraint, detach the shoulder belt and check the lap belt to determine suitability for installing a child restraint.

### **Lap and Shoulder Belt with Sewn-on Latch Plate**

With this system, the lap and shoulder portions of the safety belt are each attached to a separate retractor and both of the belts are sewn on to the same latch plate. This type of belt system may or may not be suitable for installing child restraints - it depends on the type of retractor the lap belt has.

To install a child restraint with a lap and shoulder belt with a sewn-on latch plate, ignore the shoulder belt and check the lap belt to determine suitability for installing a child restraint.

### **Belt-Positioning-Boosters, Locking Clips, and Switchable Retractors**

A belt-positioning booster (BPB) positions the lap and shoulder belt correctly on a child. A child in a BPB should use the lap and shoulder belt in its emergency locking retractor mode. In general, parents should not use a locking clip on a safety belt securing a BPB. If the shoulder belt has a switchable retractor, it should be left in the ELR mode when used to secure a BPB. Check the child restraint manufacturer's instructions for exceptions.

### **Safety Belt Tightening Devices**

CPS advocates cannot say that safety belt tightening devices used to install child restraints are good or bad. What is known is that there are no Federal regulations, requirements, or recommended testing procedures for such devices. There is also some concern about the potential for over-tightening the belt which could put undue stress on parts of the child restraint or safety belt. CPS advocates and educators cannot endorse the use of these safety belt tightening devices unless both the vehicle and child restraint manufacturers approve of using these devices with their belts and child restraints.

## **INSTALLING CHILD RESTRAINTS WITH DIFFERENT TYPES OF AUTOMATIC SAFETY BELTS**

Automatic safety belts are most commonly found in vehicles manufactured in the late 1980's and early 1990's. Most types of automatic safety belts pose problems for installing and using child restraint systems. Many of these belt systems require additional buckle parts and/or belt-shortening-clips to install a child restraint. Use another seating position. If you must install a child restraint in that position read the owner's manual or check with a Certified Technician.

## **USE OF CHILD RESTRAINTS WITH AIR BAGS**

Air bags present special concerns for children and child restraints. Any unrestrained or improperly restrained occupant is at high risk of air bag related injuries.

## **Frontal Air Bags**

Infants in rear-facing restraints are at extreme high risk when the restraint is installed in front of an active air bag. The rear-facing position places the infant's head very close to the dashboard and air bag. When the air bag deploys in a crash, it will strike the rear of the child restraint right where the infant's head is positioned and the crash forces will load to the infant's head causing severe injury, if not death.

To minimize the risk of serious air bag injury, infants and children 12 and under should sit in the back seat. Rear-facing restraints must not be installed in front of an active air bag. Parents often express concern about not being able to see their baby while driving. Healthy babies can ride unobserved with the same level of comfort that the parent has when they put their baby to bed at night or for a nap, etc. Parents must be made aware of the significant safety risk taken by choosing to place an infant in the front seat or by turning a baby around to face the front of the vehicle too soon.

A forward-facing child restraint may or may not be allowed in front of an active air bag. This will be vehicle specific and when allowed it is recommended to move the vehicle seat back as far as possible.

Single seat vehicles such as pickup trucks may have an air bag on/off switch. On/off switches allow the air bag to be turned off when a child restraint or small child is positioned in front of the air bag. It is important for the driver to remember to turn the air bag off with a child in the front seat and to remember to turn it back on, if necessary, when the child restraint is not used.

Air bag on-off switches can be installed in vehicles without them under some limited circumstances. Risk groups who can choose to have an air bag on-off switch installed in their vehicle are:

- ▶ People who must transport infants riding in rear-facing infant seats in the front passenger seat.
- ▶ People who must transport children ages 1 to 12 in the front passenger seat.
- ▶ Drivers who cannot change their customary driving position and keep 10 inches between the center of the steering wheel and the center of their breastbone.
- ▶ People whose doctors say that, due to their medical condition, the air bag poses a special risk that outweighs the risk of hitting their head, neck or chest in a crash if the air bag is turned off.

## **Side Air Bags**

There are concerns that children who are leaning against a side bag at the time of deployment can be seriously injured. Side air bags vary greatly from model to model. Because of these variations, the best source of information is the vehicle and/or child restraint manufacturer.

Refer to the vehicle owner's manual for recommendations that apply to a particular vehicle, and contact the manufacturer's customer service department with additional questions if necessary. At least one child restraint manufacturer states that their restraint devices must not be used in seating positions with side bags.

Side air bags may be disabled since they are not required safety equipment. Refer to the vehicle manufacturer for information about disabling side air bags in their vehicles.

## INSTALLING CHILD RESTRAINTS WITH TETHERS

A tether strap is the restraining strap attached near the top and in the rear of most models of forward-facing child restraints manufactured since September 1999. A tether reduces the forward movement and rotation of the child restraint. A tether strap can also provide a more secure child restraint installation in some situations of incompatibility between child restraint and vehicle.

Most passenger cars in the US since 1986 have designated tether anchor points. In general, designated anchor bracket locations are:

- ▶ For sedans, usually in the rear window shelf, directly behind the child restraint.
- ▶ For hatchbacks and station wagons, usually into or through the floor of the cargo area directly behind the child restraint. Some vehicles provide anchor locations in the ceiling or upper frame of the cargo door.
- ▶ For a pickup truck, usually into or through the rear wall directly behind the selected seating position in as near a horizontal plane with the tether as is possible considering the rear window. This does not apply to side facing jump seats.

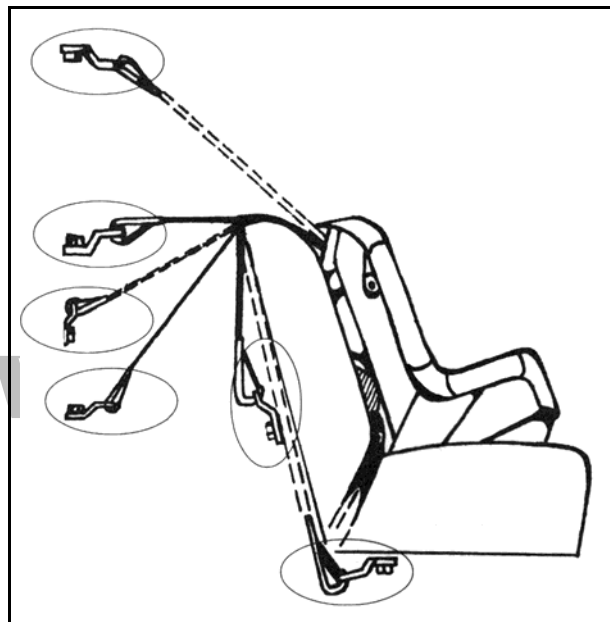

Possible Tether Anchor Locations

**WARNING:** Always check vehicle owner's manual for tether anchor location. When needed, tether anchor hardware should be obtained from vehicle dealership to ensure compatibility.

All passenger vehicles, including light trucks and vans manufactured since September 2002 are equipped with tether anchors. The vehicle industry estimates the user-ready upper anchors will be able to hold up to at least a 60-pound occupant. Heavier occupants may need special installations and help from the shoulder belt anchorage. Follow the child restraint instructions.

## INSTALLING CHILD RESTRAINTS WITH LATCH

Federal Motor Vehicle Safety Standard (FMVSS) 225 created a more universal method of installing the many different combinations of child restraints and vehicles. This system is known as "LATCH" (Lower Anchors and Tethers for CHildren). The intent of LATCH is to allow installation of child restraints independent of the vehicle safety belts. All passenger motor vehicles and child restraints manufactured since September 2002 are required to have LATCH.

### LATCH in the Vehicle

The complete LATCH system consists of two lower anchors and one upper tether anchor. Each lower anchor will be a rigid attachment point located in the vehicle seat bight (where the cushion meets the seat back). The upper tether anchor is permanently attached to the vehicle at the top or behind the rear seat. At least two rear seating positions are required to be equipped with the complete LATCH system. In addition, a third rear seating position is required to have an upper tether anchor.

**Warning:** Do not confuse cargo tie-down hooks in the cargo area with tether anchors. See vehicle owner's manual.

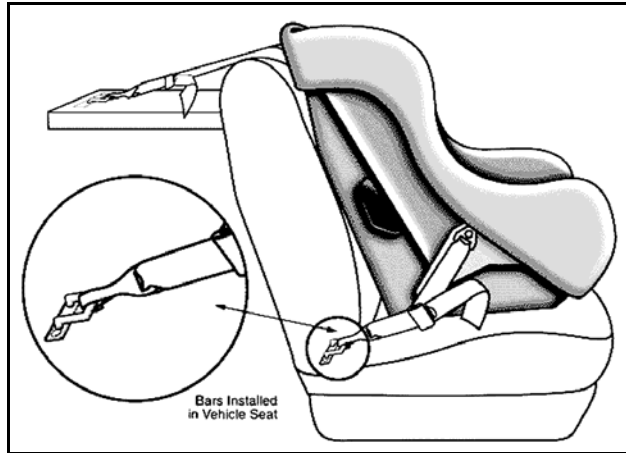

Child Restraint with Flexible Attachments

### LATCH on the Child Restraints

LATCH equipped child restraints have connectors that hook or snap onto the lower anchor bars in the vehicle. The CR's can use either a flexible or rigid lower anchor. The flexible anchor uses a hook attached to a length of webbing. The webbing is tightened after being hooked to the vehicle anchor. The rigid anchor is a metal bar or rod that clamps on to the vehicle anchor. The child restraint tether strap is attached to the vehicle tether anchor point.

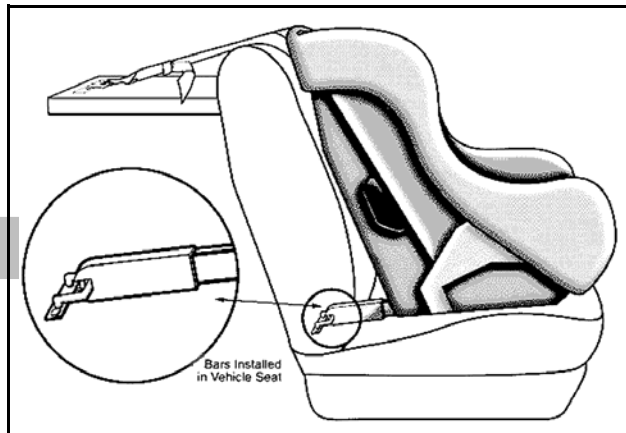

Child Restraint with Rigid Attachments

Belt-positioning boosters, car beds, and child harnesses are exempt from LATCH. In a rear-facing child restraint with a detachable base only the base must have lower anchorages. Combination seats must have the new attachments.

### New Car, Older Seat?

New vehicles are equipped with safety belts that can be used to install older CR's. In addition, new LATCH equipped child restraints can be installed in older vehicles without LATCH anchors. Most older vehicles can be retrofitted with top tether strap anchors to provide an extra margin of safety.

### Installing Child Restraints with LATCH Systems

To install a child restraint with flexible LATCH attachments:

1. Locate the lower anchor bars in the vehicle seat.
2. Position the child restraint.
3. Snap the hooks to the lower anchors.

4. Tighten the webbing on one or both sides as appropriate.
5. Attach and tighten the tether strap.
6. Check for a tight installation and correct recline angle (if appropriate).

To install a child restraint with rigid LATCH attachments, follow the same basic procedures except that the rigid lower attachments will have different ways to be adjusted. Some vehicle manufacturers supply plastic guides to help align rigid child restraint attachments with the lower anchors for easier latching.

## **OTHER VEHICLE CHARACTERISTICS AND INSTALLATION CONSIDERATIONS**

Several other aspects of vehicles may interfere with the use of child restraints or with belt fit. These include:

### **Leather Vehicle Seats**

Leather upholstery is more likely to allow child restraint to slide. It is an acceptable practice to use a thin rubber mats or shelf liner to reduce child restraint slippage.

### **Deeply Contoured Vehicle Seats**

The bases of many child restraints do not fit in deeply contoured seats. These seats often have belt buckles mounted so high that they do not fasten tightly around many restraints. These high-mounted belts also tend to ride up on the child's abdomen if the child is using the belt alone.

### **Safety Belt Anchor Type and Locations**

Rigid stems, designed to keep the belt buckle within easy reach, can place the buckle so high that the belt cannot fasten tightly around many restraints. They can also make the lap belt ride up on the child's abdomen.

The lap belt anchors forward of the seat bight may fit adults better but do not work well to install child restraints. Some belts are "asymmetrical" with one side of the belt anchored forward of the other. Tethers may be useful for forward-facing child restraints where the belt is anchored forward of the seat bight.

### **Limited Interior Space**

Small passenger compartments may restrict the use of some CR's, especially rear-facing models and shield convertibles.

### **Pull down Armrests or Consoles**

Armrests and consoles may be incompatible with rear-facing child restraints. If the manufacturer states that this is a problem, a rear-facing seat should not be placed in front of it.

### **Special Considerations for Pickup Trucks:**

- ▶ Without an "On/Off" switch or a backseat, children under the age of one cannot be safely transported in pickup trucks.
- ▶ Child restraints CANNOT be installed on side-facing jump seats.
- ▶ Rear bench seats in extended cabs may be too narrow to properly install a child restraint. Eighty percent of the child restraint base should fit on the vehicle seat.

**PREVIEW COPY**

## UNIT 7: CHILD RESTRAINT MISUSES

### REASONS FOR MISUSE

National studies indicate that about 4 out of 5 child restraints are installed or used incorrectly. There are many reasons child restraints are misused. Some are related to "human factors" while others are related to equipment.

#### Human Factors

- ▶ Failure to read instructions
- ▶ Inability to understand confusing instructions
- ▶ Choosing the "convenient way"

#### Equipment

- ▶ Many combinations of safety belts, child restraints, and vehicles creating incompatibilities
- ▶ Child restraint instructions may conflict with instructions in the vehicle owner's manual
- ▶ Lack of instructions
- ▶ Used seats are often missing parts, instructions, and labels

### TYPES OF MISUSE

#### Gross Misuse

Gross misuse makes the restraint virtually useless and is likely to result in serious injury or death. Examples of gross misuse are:

- ▶ Child restraint not secured to vehicle at all
- ▶ Child not harnessed in child restraint at all
- ▶ Infant facing the front of the vehicle before 20 pounds or before one year of age
- ▶ A rear-facing restraint installed in front of an air bag
- ▶ A rear-facing restraint being used forward-facing

#### Other Misuses

There are several ways that other misuses reduce the effectiveness of child restraints. Multiple misuses compound and become a serious danger to the child. Examples of other types of misuse include:

#### ***Restraint Selection***

- ▶ Inappropriate restraint selection
- ▶ Recalled seat not repaired
- ▶ Seat damaged or not working correctly

#### ***Harnessing Errors***

- ▶ Harness straps in wrong slot
- ▶ Harness not placed on child correctly

- ▶ Harness too loose
- ▶ Harness adjustment mechanism not locked
- ▶ Harness retainer clip too not fastened
- ▶ Harness retainer clip too high or too low
- ▶ Harness frayed, twisted, pinned, knotted or damaged

### ***Installation Errors***

- ▶ Safety belt not locked
- ▶ Safety belt locked but too loose
- ▶ Safety belt through wrong belt path
- ▶ Incorrect recline angle
- ▶ Locking clip not used or used incorrectly
- ▶ No tether used if required or incorrect use of tether system

### **Misuse of Safety Belts**

Lap belts should be worn tight and low across the hips not over the abdomen. Shoulder belts should be snug across the collarbone and middle of the chest. Safety belts are designed to restrain and protect one occupant at a time. This is important because:

- ▶ A lap belt worn too high can result in internal injuries.
- ▶ A lap/shoulder belt too loose increases upper body movement.
- ▶ A shoulder belt under the arm increases upper body movement and can result in internal injuries.
- ▶ A shoulder belt behind the back provides no upper body protection.
- ▶ Restraining two or more occupants in one safety belt increases the risk of occupant-to-occupant injury
- ▶ Any misused seatbelt is especially dangerous in front of an air bag.

## **UNIT 8: CPS PROGRAMS, SERVICES, AND RESOURCES**

### **CPS PROGRAMS AND SERVICES**

As noted in Unit 1, persons wishing to provide community child passenger safety services are encouraged to pursue CPS Technician certification after working with Certified Technicians in established local programs for a period of time. There are many opportunities for participating in local programs and activities.

#### **Child Passenger Safety Clinics**

Many organizations (fire, law enforcement, health agencies, SAFE KIDS coalitions) sponsor child passenger safety clinics periodically in their communities. This is a scheduled checkup event that provides a public service to educate parents/caregivers about the correct use of child restraints. Teams of checkers, headed by Certified Technicians, teach caregivers the basics of correct selection, use, and installation of child restraints. The clinic also provides an excellent opportunity for checkers to identify unsafe child restraints and gain experience in diagnosing misuse. A clinic that has child restraints available for the individuals that do not have the resources to purchase their own will be most effective. In order to conduct a successful clinic, an event coordinator will need to organize and promote the event well in advance.

#### **Permanent Checking Stations**

Many public health and safety agencies have established permanent stations or sites for parents/caregivers to get assistance with their child restraint. Permanent checking stations (PCS) have a regular schedule of operation. Some sites require appointments and others allow drive-ups. Nationally certified and experienced CPS technicians must be available during hours of operation.

#### **Child Restraint Distribution Programs**

Some organizations and agencies participate in a child restraint distribution program that provides child restraints to families, identified as needy or who receive public assistance. In some cases, the recipient may be asked to make a donation to receive the CR.

#### **Your Responsibility as a Child Passenger Safety Advocate**

- ▶ Know your limitations
- ▶ Know when to say "I don't know"
- ▶ Learn local and state resources
- ▶ Stay updated and seek additional training
- ▶ Document! Document! Document!
- ▶ Work within your community

**PREVIEW COPY**

## APPENDICES

North Carolina and National CPS Resources

Summary of North Carolina Occupant Restraint Laws

Text of North Carolina Occupant Restraint Laws

North Carolina Child Passenger Safety Law: Questions Commonly Asked

Transportation of Children by Schools, Child Care Centers and other Organizations in NC and Homes

North Carolina Seat Belt Law: Questions Commonly Asked

Requirements of the North Carolina Children in Back of a Pickup Truck Law

Growing Up Buckled Up in North Carolina: Basics of NC Laws and Best Practice Recommendations

Buyer's Guide to Used Child Restraints

Recommendations for Replacement of Crash-Involved Safety Belts & Child Restraints

Installation of Child Safety Seats with Different Types of Seat Belts

Child Occupant Protection Glossary

English to Spanish Glossary

Spanish to English Glossary

PREVIEW COPY

**PREVIEW COPY**

## NORTH CAROLINA AND NATIONAL CHILD PASSENGER SAFETY RESOURCES

### NORTH CAROLINA:

#### **NC Governor's Highway Safety Program (GHSP)**

215 E. Lane Street  
Raleigh, NC 27601  
919-733-3083 / 800-999-9676  
[www.ncdot.org/secretary/ghsp](http://www.ncdot.org/secretary/ghsp)

GHSP is the state agency serving as overall coordinator for highway safety programs in North Carolina and is the primary source for NC specific traffic safety related materials and funding.

---

#### **NC Department of Insurance Office of the State Fire Marshal**

322 Chapanoke Road  
1202 Mail Service Center  
Raleigh, NC 27699-1202  
800-634-7854 / 919-661-5880  
[www.ncsafekids.org](http://www.ncsafekids.org)

The NC DOI OSFM Injury Prevention Program serves as the coordinating agency for:

- **NC SAFE KIDS Buckle Up** involves fire and rescue personnel as well as other health and safety advocates in safety seat distribution and education programs. NC child passenger safety activities are coordinated through the Buckle Up program. The Buckle Up Program coordinates child passenger safety training programs for the state.
  - **NC SAFE KIDS** is affiliated with the National SAFE KIDS Campaign to combat the causes of deaths among children caused by unintentional injuries. The NC Coalition works to address the major unintentional risk areas of traffic incidents, fire/burns, drowning, falls, poisonings, and choking/suffocation.
  - **Buckle Bear** is a program that teaches young children about car seat, passenger (car seats, seat belts and air bags), pedestrian, and bicycle safety. This curriculum with reusable material is targeted for children ages 2-6. The Buckle Bear program has many teaching tools including puppets and a tape that is used with the puppet to make the program lots of fun for the children.
  - **Risk Watch** is a comprehensive injury prevention program designed for use in the classroom, giving children and their families the skills and knowledge they need to create safer homes and communities. Risk Watch addresses the eight risk areas that kill or injure the most children each year: motor vehicle crashes; fires and burns; choking, suffocation and strangulation; poisonings; falls; unintentional firearm accidents; bike and pedestrian hazards and water hazards.
-

## NORTH CAROLINA AND NATIONAL CHILD PASSENGER SAFETY RESOURCES

### **El Pueblo, Inc**

4 North Blount Street  
2nd Floor  
Raleigh, NC 27601  
919-835-1525  
[www.elpueblo.org](http://www.elpueblo.org)

A North Carolina non-profit statewide advocacy and public policy organization dedicated to strengthening the Latino community through leadership development, education, and promotion of cross-cultural understanding in partnerships at the local, state, and national levels. El Pueblo is the primary coordinating agency for Nuestra Seguridad, a statewide coalition that strives to reduce the disproportionate amount of highway safety fatalities among Hispanic drivers in North Carolina through the development and distribution of culturally appropriate Spanish-language materials on highway safety. A list of free materials available through the campaign is on El Pueblo's website.

---

### **NC State Highway Patrol Traffic Safety Information Programs**

512 N. Salisbury Street  
4702 Mail Service Center  
Raleigh, NC 27699-4702  
919-733-7952  
[www.ncshp.org](http://www.ncshp.org)

The Patrol's Traffic Safety Information Officers can provide a variety of traffic safety related educational programs including their BIBS (Buckle In Baby Safely) program.

---

### **University of North Carolina Highway Safety Research Center**

CB #3430  
730 Airport Road, Suite 300  
Chapel Hill, NC 27599  
800-672-4527 / 919-962-2202  
[www.hsrc.unc.edu](http://www.hsrc.unc.edu)  
[www.buckleupnc.org](http://www.buckleupnc.org)

HSRC operates the NC Child Passenger Safety Resource Center and coordinates NC Child Passenger Safety training activities, is the host for [buckleupnc.org](http://buckleupnc.org), and maintains an in-state toll-free phone line to answer child restraint and seat belt questions for parents and CPS advocates.

---

## NORTH CAROLINA AND NATIONAL CHILD PASSENGER SAFETY RESOURCES

**NC Department of Health and Human Services**  
**Division of Child Development**  
2201 Mail Service Center  
Raleigh, NC 27626-2201  
800-859-0829 (in-state calls only) / 919-662-4499

The Division of Child Development oversees all aspects of child care services in North Carolina including the regulation of child care facilities. Transportation regulations for NC child care providers require that they adhere to the NC CPS law and also include additional standards relating to child-to-staff ratio, climate control, cleanliness, and safety.

### **NATIONAL:**

**American Academy of Pediatrics**  
Publications Department  
P.O. Box 927  
Elk Grove Village, IL  
800-433-9016 / 317-274-2977  
[www.aap.org](http://www.aap.org)

Publishes CPS policy statements, pamphlets on child restraint use, and a CR shopping guide including one for transporting children with special needs.

PREVIEW COPY

**Automotive Safety Program, Riley Hospital for Children**  
575 West Drive, Room 004  
Indianapolis, IN 46202  
800-543-6227 (Indiana only)  
317-274-2977  
[www.preventinjury.org](http://www.preventinjury.org)

Information available for transporting children with special needs including ambulance transport safety.

**Children's Hospital of Philadelphia**  
3535, TraumaLink, 10th Floor  
Philadelphia, Pa. 19104-4399  
800-879-2467  
215-590-3118  
[www.chop.edu/carseat](http://www.chop.edu/carseat)

Partners for Child Passenger Safety is a research partnership of The Children's Hospital of Philadelphia, and the University of Pennsylvania, and State Farm Insurance developed to study how and why children are injured and killed in motor vehicle crashes and to help parents and caregivers learn more about child safety seats, booster seats and seatbelts. The Partners team has studied more than 300,000 motor vehicle crashes to learn more about child safety. Research findings and factsheets can be found through their Safety Research at TraumaLink: Experts Working Together to Protect Children From Injury site.

## NORTH CAROLINA AND NATIONAL CHILD PASSENGER SAFETY RESOURCES

The information on their Keeping Kids Safe During Crashes: Every Child Deserves a Safe Ride site includes videos and other useful information on installing and using child safety seats and on seat belt use for older children and quick tips to help you review the information and links to other online resources.

Partners for Child Passenger Safety now has a Spanish version of their "Keeping Kids Safe" site on their Cómo mantener a los niños fuera de peligro durante los choques: Todos los niños merecen viajar seguros site.

---

### **Insurance Institute for Highway Safety**

Communications Dept.  
1005 N. Glebe Rd.  
Arlington, VA 22201  
703-247-1500  
[www.hwysafety.org](http://www.hwysafety.org)

Distributes the newsletter "Status Report", and produces low-cost videos on a variety of highway safety topics. Produce fact sheets and lists of state seat belt and child passenger safety laws.

---

### **National SAFE KIDS Campaign**

1301 Pennsylvania Ave., NW  
Suite 1000  
Washington, DC 20004  
202-662-0600  
[www.safekids.org](http://www.safekids.org)

PREVIEW COPY

A resource for parents and CPS advocates relating to unintentional injuries to children. NSK serves as the certifying body for the National Standardized Child Passenger Safety Training Program.

---

### **National Highway Traffic Safety Administration (NHTSA)**

Office of Occupant Protection, NTS-13  
400 Seventh Street, S.W.  
Washington, DC 20590  
202-366-0910  
Auto Safety Hotline 1-888-327-4236  
[www.nhtsa.dot.gov](http://www.nhtsa.dot.gov)

NHTSA is the federal agency that establishes and enforces motor vehicle safety standards. Establishes and promotes national and state highway safety related programs and materials including child passenger safety. Pamphlets, technical reports, program manuals, car seat Manufacturers' Instruction Manuals, recall lists, etc. are available through NHTSA.

---

## NORTH CAROLINA AND NATIONAL CHILD PASSENGER SAFETY RESOURCES

### **National Child Passenger Safety Board**

1025 Connecticut Avenue N.W., Suite 1200  
Washington, D.C. 20036-5405  
202-296-6263  
[www.cpsboard.org](http://www.cpsboard.org)

The National Child Passenger Safety Board provides direction to the standardized NHTSA Child Passenger Safety Training curriculum and National SAFE KIDS Certification Program.

---

### **Safe Ride News**

Safe Ride News Publications, Inc.  
The Willapa Bay Company  
Lake Forest Park, WA  
800-403-1424 / 206-364-5696  
[www.saferidenews.com](http://www.saferidenews.com)

Safe Ride News is a national newsletter with technical updates related to child passenger, pedestrian, and bicycle safety. Available by subscription.

---

### **Safety BeltSafe U.S.A. (SBS USA)**

P.O. Box 553  
Altadena, CA 91001  
310-673-2666 / 800-745-7233 [SAFE]  
800-747-7266 [SANO] (Spanish)  
[www.carseat.org](http://www.carseat.org)

Pamphlets in multiple languages, flyers on correct use of CRs, training courses and materials, supplement to NHTSA distributed Manufacturers' Instructions Notebook, recall list, and other materials.

**PREVIEW COPY**

**NORTH CAROLINA'S OCCUPANT RESTRAINT LAWS:  
EFFECTIVE AS OF JANUARY 1, 2005**

<b>Child Passenger Safety G.S. 20-137.1</b>	<b>Seat Belt G.S. 20-135.2A</b>	<b>Children in Pickup Trucks G.S. 20-135.2B</b>
<p><b>Ages/Positions Covered:</b></p> <ul style="list-style-type: none"> <li>▶ Children less than age 16 in front or back seats.</li> </ul> <p><b>Vehicles Covered:</b></p> <ul style="list-style-type: none"> <li>▶ All vehicles required by federal standards to have seat belts. [Cars made after 1967 and light trucks/vans made after 1971.]</li> </ul> <p><b>Restraint Required:</b></p> <ul style="list-style-type: none"> <li>▶ Any type of properly used child restraint device (CRD) meeting Federal standards (FMVSS 213) in effect at time of manufacture if child is less than age 8 AND less than 80 pounds.</li> <li>▶ For children &lt; than age 5 and &lt; 40 lbs., the CRD must be in the rear seat if the vehicle has an active passenger side air bag and a rear seat [unless the CRD is designed for use with air bags].</li> <li>▶ Children may be secured in a properly fitted seat belt at age 8 OR if they reach 80 pounds before their 8th birthday.</li> <li>▶ If there is no lap and shoulder belt available for a belt-positioning booster, a child &lt;8 years and &gt;40 pounds may be restrained by a properly fitted lap belt only.</li> </ul> <p><b>Exemptions:</b></p> <ul style="list-style-type: none"> <li>▶ Vehicles not required to have seat belts.</li> <li>▶ Ambulances and other emergency vehicles</li> <li>▶ If child's "personal needs" are being tended to.</li> <li>▶ If all seating positions with belts are occupied.</li> </ul> <p><b>Responsibility/Penalties:</b></p> <ul style="list-style-type: none"> <li>▶ Driver responsible for all children less than sixteen.</li> <li>▶ Penalty not to exceed \$25.</li> <li>▶ Court costs apply.</li> <li>▶ Two (2) driver license points.</li> <li>▶ No insurance points.</li> <li>▶ No conviction if child is less than 8 and proof presented at trial that CRD has been acquired since violation for vehicle normally used to transport child.</li> </ul>	<p><b>Ages/Positions Covered:</b></p> <ul style="list-style-type: none"> <li>▶ All drivers and front seat passengers ages 16 and older.</li> </ul> <p><b>Vehicles Covered:</b></p> <ul style="list-style-type: none"> <li>▶ All passenger vehicles with capacity of &lt;11 occupants required by federal standards to have seat belts. [Cars made after 1967 and light trucks/vans made after 1971.]</li> </ul> <p><b>Restraint Required:</b></p> <ul style="list-style-type: none"> <li>▶ Full restraint system provided for the seating position.</li> <li>▶ Requires lap and shoulder belt be used if provided even if the system is automatic shoulder belt or air bag is provided.</li> </ul> <p><b>Exemptions:</b></p> <ul style="list-style-type: none"> <li>▶ Vehicles not required to have belts.</li> <li>▶ Professionally certified medical condition or mental phobia preventing use.</li> <li>▶ Rural letter carriers and newspaper carriers while performing duties.</li> <li>▶ Frequently stopping delivery vehicles if speed between stops does not exceed 20 mph.</li> <li>▶ Vehicles with "Farm" or "Commercial" license plates while being used for agricultural purposes.</li> </ul> <p><b>Responsibility/Penalties:</b></p> <ul style="list-style-type: none"> <li>▶ Driver responsible for self and all children less than sixteen.</li> <li>▶ Ages sixteen and older responsible for selves.</li> <li>▶ Penalty of \$25.</li> <li>▶ No court costs apply.</li> <li>▶ No driver license or insurance points.</li> </ul>	<p><b>Ages/Positions Covered:</b></p> <ul style="list-style-type: none"> <li>▶ Children less than age 12 in open bed or open cargo area.</li> </ul> <p><b>Vehicles Covered:</b></p> <ul style="list-style-type: none"> <li>▶ Vehicles having open beds or cargo areas without permanent overhead restraining construction.</li> </ul> <p><b>Restraint Required:</b></p> <ul style="list-style-type: none"> <li>▶ Transport in open bed or open cargo area prohibited.</li> </ul> <p><b>Exemptions:</b></p> <ul style="list-style-type: none"> <li>▶ If adult is present in bed or cargo area and is supervising the child.</li> <li>▶ If child is secured or restrained by seat belt in compliance with FMVSS 208 installed to support load of 5000 lbs. for each belt and of a type approved by the Commissioner.</li> <li>▶ An emergency situation exists</li> <li>▶ Vehicle is being operated in a parade pursuant to a valid permit.</li> <li>▶ Vehicle is being operated for agricultural purposes.</li> <li>▶ In counties with no incorporated town with a population greater than 3,500*.</li> </ul> <p><b>Responsibility/Penalties:</b></p> <ul style="list-style-type: none"> <li>▶ Driver responsible for all children less than twelve.</li> <li>▶ Penalty of \$25.</li> <li>▶ No court costs apply.</li> <li>▶ No driver license or insurance points.</li> </ul> <p>*Counties with &lt;3,500 population: Alexander, Alleghany, Ashe, Avery, Bertie, Camden, Caswell, Cherokee, Clay, Currituck, Duplin, Franklin, Gates, Graham, Green, Hyde, Jackson, Jones, Macon, Madison, Mitchell, Montgomery, Northhampton, Pamlico, Pender, Perquimans, Polk, Swain, Tyrrell, Warren, Yadkin, and Yancey</p>

**PREVIEW COPY**

# NORTH CAROLINA CHILD PASSENGER SAFETY LAW

*Effective: January 1, 2005*

## § 20-137.1. Child restraint systems required.

(a) Every driver who is transporting one or more passengers of less than 16 years of age shall have all such passengers properly secured in a child passenger restraint system or seat belt which meets federal standards applicable at the time of its manufacture.

(a1) A child less than eight years of age and less than 80 pounds in weight shall be properly secured in a weight- appropriate child passenger restraint system. In vehicles equipped with an active passenger-side front air bag, if the vehicle has a rear seat, a child less than five years of age and less than 40 pounds in weight shall be properly secured in a rear seat, unless the child restraint system is designed for use with air bags. If no seating position equipped with a lap and shoulder belt to properly secure the weight-appropriate child passenger restraint system is available, a child less than eight years of age and between 40 and 80 pounds may be restrained by a properly fitted lap belt only.

(b) The provisions of this section shall not apply: (i) to ambulances or other emergency vehicles; (ii) when the child's personal needs are being attended to; (iii) if all seating positions equipped with child passenger restraint systems or seat belts are occupied; or (iv) to vehicles which are not required by federal law or regulation to be equipped with seat belts.

(c) Any driver found responsible for a violation of this section may be punished by a penalty not to exceed twenty-five dollars (\$25.00), even when more than one child less than 16 years of age was not properly secured in a restraint system. No driver charged under this section for failure to have a child under eight years of age properly secured in a restraint system shall be convicted if he produces at the time of his trial proof satisfactory to the court that he has subsequently acquired an approved child passenger restraint system for a vehicle in which the child is normally transported.

- (d) A violation of this section shall have all of the following consequences:
- (1) Two drivers license points shall be assessed pursuant to G.S. 20-16.
  - (2) No insurance points shall be assessed.
  - (3) The violation shall not constitute negligence per se or contributory negligence per se.
  - (4) The violation shall not be evidence of negligence or contributory negligence."

This act becomes effective January 1, 2005.

## NORTH CAROLINA SEAT BELT LAW

### § 20-135.2A. Seat belt use mandatory.

(a) Each front seat occupant who is 16 years of age or older and each driver of a passenger motor vehicle manufactured with seat belts shall have a seat belt properly fastened about his or her body at all times when the vehicle is in forward motion on a street or highway in this State.

(b) "Passenger Motor Vehicle," as used in this section, means a motor vehicle with motive power designed for carrying 10 passengers or fewer, but does not include a motorcycle, a motorized pedacycle or a trailer.

(c) This section shall not apply to any of the following:

- (1) A driver or occupant with a medical or physical condition that prevents appropriate restraint by a safety belt or with a professionally certified mental phobia against the wearing of vehicle restraints;
- (2) A motor vehicle operated by a rural letter carrier of the United States Postal Service while performing duties as a rural letter carrier and a motor vehicle operated by a newspaper delivery person while actually engaged in delivery of newspapers along the person's specified route;
- (3) A driver or passenger frequently stopping and leaving the vehicle or delivering property from the vehicle if the speed of the vehicle between stops does not exceed 20 miles per hour;
- (4) Any vehicle registered and licensed as a property-carrying vehicle in accordance with G.S. 20-88, while being used for agricultural or commercial purposes; or
- (5) A motor vehicle not required to be equipped with seat safety belts under federal law.

(d) Evidence of failure to wear a seat belt shall not be admissible in any criminal or civil trial, action, or proceeding except in an action based on a violation of this section or as justification for the stop of a vehicle or detention of a vehicle operator and passengers.

(e) Any driver or passenger who fails to wear a seat belt as required by this section shall have committed an infraction and shall pay a penalty of twenty-five dollars (\$25.00) plus court costs in the sum of fifty dollars (\$50.00). Court costs assessed under this section are for the support of the General Court of Justice and shall be remitted to the State Treasurer. Conviction of an infraction under this section has no other consequence.

(f) No drivers license points or insurance surcharge shall be assessed on account of violation of this section.

(g) The Commissioner of the Division of Motor Vehicles and the Department of Public Instruction shall incorporate in driver education programs and driver licensing programs instructions designed to encourage compliance with this section as an important means of reducing the severity of injury to the users of restraint devices and on the requirements and penalties specified in this law.

*Effective October 1, 2002.*

## NORTH CAROLINA CHILDREN IN BACK OF PICKUP TRUCK LAW

### **§ 20-135.2B. Transporting children under 12 years of age in open bed or open cargo area of a vehicle prohibited; exceptions.**

(a) The operator of a vehicle having an open bed or open cargo area shall insure that no child under 12 years of age is transported in the bed or cargo area of that vehicle. An open bed or open cargo area is a bed or cargo area without permanent overhead restraining construction.

(b) Subsection (a) of this section does not apply in any of the following circumstances:

- (1) An adult is present in the bed or cargo area of the vehicle and is supervising the child.
- (2) The child is secured or restrained by a seat belt manufactured in compliance with Federal Motor Vehicle Safety Standard No. 208, installed to support a load strength of not less than 5,000 pounds for each belt, and of a type approved by the Commissioner.
- (3) An emergency situation exists.
- (4) The vehicle is being operated in a parade pursuant to a valid permit.
- (5) The vehicle is being operated in an agricultural enterprise.
- (6) The vehicle is being operated in a county that has no incorporated area with a population in excess of 3,500.

(c) Any person violating this section shall have committed an infraction and shall pay a penalty of twenty-five dollars (\$25.00). Conviction of an infraction under this section has no consequence other than payment of a penalty. A person found responsible for a violation of this section may not be assessed court costs.

(d) No drivers license points or insurance surcharge shall be assessed on account of violation of this section.

*Effective October 1, 1999.*

**PREVIEW COPY**

# The North Carolina Child Passenger Safety & Booster Seat Law: Commonly Asked Questions

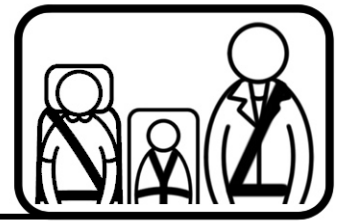

## What are the basic requirements of this law?

- ◆ All children less than 16 years of age must be properly restrained in all vehicle seating positions. Drivers and occupants 16 and older are covered by the NC Seat Belt Law.
- ◆ Vehicles covered are those required by federal standards to be equipped with seat belts. This includes cars made since 1968 as well as pickup trucks, sport utility vehicles, and vans made since 1972. Ambulances and other emergency vehicles are exempt.
- ◆ Children younger than age 8 AND who weigh less than 80 pounds must be properly secured in CRs appropriate for their weight and height. Most drivers will be able to comply with the changes by using belt-positioning booster seats for children over 40 pounds. Belt-positioning boosters raise children up to make lap and shoulder combination belts fit correctly.
- ◆ When a child reaches age 8 (regardless of weight) OR 80 pounds (regardless of age), a properly fitted seat belt may be used to restrain the child. Shoulder belts behind the back or under the arm are not allowed.
- ◆ If there is no lap and shoulder belt equipped seating position available for using a belt-positioning booster, a child who weighs at least 40 pounds may be restrained by a properly fitted lap belt only. **WARNING:** Belt-positioning booster seats can only be used with lap and shoulder combination safety belts. Belt-positioning booster seats must NEVER be used with just a lap belt.

### Basic Types of Restraints

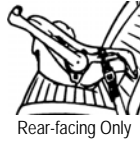

Rear-facing Only



Rear-facing Convertible



Front-facing Convertible



High Back Belt Positioning Booster



Backless Belt Positioning Booster



Lap and Shoulder Belt

## Is it "8 OR 80" or "8 AND 80"???

In part the answer lies in which question is being asked:

Q: "Which children are required to be in a booster seat or other child restraint?"

A: Children who are both less than age 8 AND less than 80 pounds are required to be in some type of child restraint. Note that "some type of child restraint" includes booster seats.

Q: "When can children be switched to seat belts alone?"

A: Children may be restrained by properly fitted seat belts when they reach age 8 (regardless of weight) OR reach 80 pounds (regardless of age).

◆ Note, however, that a child who has reached 40 pounds, regardless of age, may be restrained by just a properly fitted lap belt if there is not a lap and shoulder belt equipped seating position available for using a belt-positioning booster seat.

◆ There are no booster seats currently being made that can be used with just a lap belt. Belt-positioning booster seats may only be used with lap and shoulder combination belts and must NEVER be used with just a lap belt.

## Which car seats are approved for use in NC, and how can I tell if I have an approved seat?

◆ Any type of child restraint (CR) is legal to use as long as: 1) It is certified to meet Federal Motor Vehicle Safety Standard 213; 2) the child is within the weight range specified for the CR; and 3) the CR is being used correctly according to the

manufacturer's instructions.

- ◆ Car booster seats, harnesses, and CR's built into vehicles are legal and safe to use. Look for labels on the CR which certifies that it meets federal standards for use in a motor vehicle and gives the model number and date of manufacturer.
- ◆ A child restraint should not be used if it has labels missing, or it is older than 10 years, or if it has missing or broken parts. CRs that have previously been involved in severe crashes should not be used either.

## When can infants be turned around to face the front of the car?

- ◆ In NC it is legal to turn an infant to face the front of the vehicle whenever the manufacturer of the child restraint (CR) being used allows it. However, the American Academy of Pediatrics (AAP) recommends that infants be kept rear-facing as long as possible but at least until 1 year of age AND at least 20 pounds.
- ◆ Most current convertible CR's, those that can be used either rear- or front-facing, can be used up to at least 30 pounds rear-facing.

## When can children be put in a booster seat?

- ◆ It is legal to switch to a booster seat at any weight as long as the child is within the booster's weight range. However, it is not generally recommended to use booster seats until after the front-facing child restraint (CR) with a harness is outgrown, usually about 40 pounds.
- ◆ Belt-positioning booster seats, designed to make lap and shoulder belts fit correctly on children and youth, should be used. **WARNING:** Belt-positioning boosters must be used with vehicle lap and shoulder combination seat belts - NEVER with just a lap belt.
- ◆ Older shield type booster seats, those with just a padded bar or shield in front of the child, no longer meet Federal standards, are no longer being made and are not generally recommended.

## When is my child big enough for a seat belt?

- ◆ Effective January 1, 2005, NC law does not allow the use of a lap and shoulder combination seat belt until a child is at least 8 years old OR at least 80 pounds, whichever comes first.
- ◆ In addition to the legal requirements, properly fitted lap belts fit low and snug across the hips and should be at least touching the upper thighs. Properly fitted shoulder belts must fit correctly across the collar bone and chest.
- ◆ An improperly fitted seat belt, with the shoulder belt placed under the arm or behind the back, is neither legal nor safe for children or adults. Improper use such as this can lead to serious injuries to the head, internal organs, or spine in a crash.
- ◆ Add-on shoulder belt adjusters are not legal, nor are they recommended, since they are not covered by any Federal standards and may, in fact, do more harm than good.
- ◆ SafetyBeltSafe U.S.A. has developed a simple "5-Step Test" to see if a child is big enough to ride in a lap and shoulder belt combination. If you answer "no" to any of these questions, your child needs a booster seat to ride safely and comfortably in the car:

- 1) Does the child sit all the way back against the auto seat?
- 2) Do the child's knees bend comfortably at the edge of the auto seat?
- 3) Does the belt cross the shoulder between the neck and arm?
- 4) Is the lap belt as low as possible, touching the thighs?
- 5) Can the child stay seated like this for the whole trip?

**Do children have to ride in the back seat?**

- ◆ NC law requires that a child restraint (CR) be properly installed in the rear seat if the child is less than 5 years of age and less than 40 pounds in weight and the vehicle has an active passenger side air bag.
- ◆ The CR may be installed in the front seat if it is designed for use with air bags or if the vehicle has an air bag on-off switch that is turned off.
- ◆ Regardless of what is legal, it is strongly recommended that:
  - ▶ All children age 12 and under should ride buckled up in a rear seat in restraints appropriate for their ages and sizes.
  - ▶ Infants in rear facing child restraints should NEVER ride in the front seat of a vehicle with an active passenger side air bag.
  - ▶ If a child over 1 year old MUST ride in the front seat with a passenger side air bag, put the child in a front facing full harness CR, belt-positioning booster seat, or a properly fitted lap and shoulder belt and move the vehicle seat as far back as possible.

**Who is responsible for the children in a car?**

- ◆ The driver is responsible for obeying the law and would get the ticket even if the child's parent is also in the car.

**What are the penalties for violations of this law?**

- ◆ Violations carry a fine of up to \$25 plus court costs (currently about \$100) plus two driver license points.

**What are the differences between what the NC law allows and what is recommended for buckling up children?**

- ◆ What is allowed under this law can be considered to be "minimum standards" and is not necessarily what is recommended to provide the best protection for a child or adult.
- ◆ For best protection, recommendations are that:
  - ▶ Children should ride in a rear-facing-only or rear-facing convertible child restraint (CR) as long as possible but at least until one year of age AND at least 20 pounds.
  - ▶ Once turned around facing to the front, children should ride in a front-facing seat with a full harness or harness-shield until it is outgrown, usually at about 40 pounds. Several models can be used with their harnesses over 40 pounds.
  - ▶ Children should switch to a belt-positioning booster seat when the full harness seat is outgrown and continue riding in the booster seat until the seat belt fits correctly without the booster seat - but remember that NC law does not allow the use of a seat belt for most children until 8 years or 80 pounds.
  - ▶ Children should not be switched to a seat belt until the child is big enough for a correct fit of the belt and is mature enough to sit reasonably still.
  - ▶ Lap belts alone should be used if nothing else is available. Currently, there are no boosters on the market certified for use over 40 pounds in a lap-belt-only position, so options for larger children are limited. Safer options for lap-belt-only positions are as follow:
    - ▶ Purchase and use one of the few full harness CRs with weight ranges higher than 40 pounds.
    - ▶ Order, install, and use a harness that is designed for children over 40 pounds. These require extra installation, but do provide good upper body protection in lap belt only positions.

- ▶ Check with your local car dealer or vehicle manufacturer to see if retrofit shoulder belt kits are available for the rear seat. If so, these can be installed and a child can be secured in a belt-positioning booster.
- ▶ No one should ever ride unrestrained in the vehicle or in a non-belted position such as the cargo area of a station wagon or pickup truck.

**How important is it that car seats are used the way the instructions say?**

- ◆ Child restraints (CRs) that are not used correctly lose much of their ability to protect children in crashes. Correct use requires three important steps:
  - 1) the CR must be the right type for the size of the child,
  - 2) the child must be buckled correctly into the CR, and
  - 3) the CR must be correctly buckled to the car.
- ◆ If you have any questions about the proper use of child restraints or need to obtain complete manufacturer's instructions, call the manufacturer or the UNC Highway Safety Research Center.

**Are there any exemptions to this law?**

- ◆ Vehicles not required to have seat belts are exempt. Also, children may be left unbuckled if all belted seating positions are occupied and children may be removed from their seats to "tend to personal needs" such as nursing or changing a diaper.
- ◆ These exemptions were added to get the law first passed in 1981 and have never been removed. They have never been considered to be safe practices. Indeed, children have been killed when crashes happened right after being taken out of their restraints for "just a minute."

**Are organizations such as schools, churches, and child care centers covered under this law?**

- ◆ No organizations - including public and private schools, churches, child care centers, and camps - are exempt from the NC CPS Law. Any organization or agency transporting children in vehicles required by Federal standards to have seat belts must comply with all provisions of the NC CPS law.
- ◆ Most buses, including school, charter and public transit buses, are not required to be equipped with seat belts and thus are exempt from the NC CPS law. School buses do not have seat belts because they rely on strong, closely spaced, well-padded, energy absorbing seats and higher seat backs to "compartmentalize" and protect passengers during a crash.
- ◆ Note, however, that seat belts are required on small school buses (under 10,000 lbs) and children being transported in these smaller buses are covered under this law.
- ◆ Refer to "Transportation of Children by Schools, Child Care Centers and other Organizations in NC and Homes", available through [www.buckleupnc.org](http://www.buckleupnc.org) for more information.

**Can I let my children ride in the back of a pickup truck?**

- ◆ A separate NC law prohibits most children less than age 12 from riding in the open bed of a pickup truck or other cargo area. No child or adult should ride in the bed of a pickup truck or any other place in the vehicle not designated as a seating position.

For further information contact:

**UNC Highway Safety Research Center**  
800-672-4527 / 919-962-2202  
[www.buckleupnc.org](http://www.buckleupnc.org)  
[www.hsrc.unc.edu](http://www.hsrc.unc.edu)

For further information or to order brochures or other educational materials, contact:

**NC Governor's Highway Safety Program**  
800-999-9676 / 919-733-3083  
[www.ncdot.org/secretary/GHSP](http://www.ncdot.org/secretary/GHSP)

**NC Department of Insurance**  
**NC Safe Kids Buckle Up**  
888-347-3737 / 919-661-5880  
[www.ncsafekids.org](http://www.ncsafekids.org)

# Requirements and Recommendations for the Transportation of Children by Schools, Child Care Centers and other Organizations in North Carolina



## Basic Provisions of the NC Child Passenger Safety (CPS) Law:

- All children less than 16 years old must be buckled up in either the front or back seat of any vehicle required by federal standards to be equipped with safety belts.
- Drivers are responsible for all children and youth less than age 16 in the vehicle.
- A child who is younger than age 8 AND who weighs less than 80 pounds must be properly secured in a child passenger restraint device (CRD) or booster seat.
- When a child reaches age 8 (regardless of weight) OR 80 pounds (regardless of age), a properly fitted safety belt may be used.
- A child who weighs at least 40 pounds may be restrained by a properly fitted lap-belt-only if no seating position equipped with a lap and shoulder belt is available. All lap and shoulder belt positions must be occupied before the lap-only safety belt is allowed.

### Basic Types of Restraints

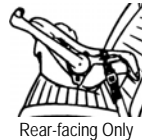

Rear-facing Only



Rear-facing Convertible



Front-facing Convertible

No type of organization is exempt from the NC CPS Law, only types of vehicles. In addition, some programs may be subject to additional state and/or federal regulations as noted below.

**WARNING:** Belt-positioning booster seats must NEVER be used with just a lap belt. Belt-positioning booster seats can only be used with lap and shoulder safety belts.



Belt Positioning Booster

## Transporting Children in 15-Passenger Vans

15-passenger vans are required to have safety belts in all seating positions and are covered under the NC Child Passenger Safety Law. Organizations using vans or other passenger vehicles to transport children must comply with all provisions of the NC CPS law. Some programs, however, may be subject to additional state, federal, or program-specific regulations that prohibit the use of vans for transporting children unless they are built to school bus standards. (See "Additional State and Federal Regulations.")



Lap and Shoulder Belt

Older models of vans may have lap-belt-only safety belts in all rear seats. In this case, children less than 40 pounds in weight are required to be in a front-facing restraint with a harness. Children weighing at least 40 pounds can be in just the lap belt without a booster seat.



Lap Belt with Harness

Some rear seat positions in newer vans are equipped with lap and shoulder combination belts. If this is the case:

1. Place children less than 40 pounds in child restraints with harnesses and install these restraints in lap-belt-only positions.
2. Place children who are at least 8 years old OR weigh at least 80 pounds in properly fitted lap and shoulder safety belts. Shoulder belts tucked under the arm or placed behind the back are **ILLEGAL** and **UNSAFE**.
3. Place children less than age 8 AND less than 80 pounds in remaining lap and shoulder belt positions in belt positioning boosters.
4. Place children who are at least 40 pounds in any remaining lap-belt-only positions using just the lap belt. **DO NOT** use belt-positioning booster seats in the lap-belt-only positions.

## Transporting Children in School Buses

Federal standards do not require safety belts on large buses with Gross Vehicle Weight Ratings (GVWR) of more than 10,000 pounds. School buses rely on strong, closely spaced, well-padded, energy absorbing seats and higher seat backs to "compartmentalize" and protect passengers during a crash. The size and construction of school buses as well as compartmentalization make them very safe vehicles.

Large buses are exempt from the NC CPS Law since they are not required to have safety belts. This exemption includes large school and activity buses as well as municipal transit and charter buses. Organizations that provide transportation on large buses do not have to install safety belts and use child restraints for the children being transported in order to comply with this law unless the organization is subject to additional standards and regulations. (See "Additional State and Federal Regulations.")

Safety belts are required on small buses that weigh 10,000 pounds or less. Some school buses (Types A1 and B1) fit into this category. Children being transported in these smaller buses are covered under the NC CPS law. Most of the safety belts on these smaller buses are lap-belt-only safety belts. Children less than 40 pounds in weight are required to be in a child restraint appropriate for their weight. Children who weigh 40 pounds or more can be restrained by just the lap belt without a booster seat.

**WARNING:** Belt-positioning booster seats must NEVER be used with just a lap belt. Belt-positioning booster seats can only be used with lap and shoulder safety belts.

Operators of smaller buses (under 10,000 lbs) required to have safety belts are subject to the NC CPS law and must comply. Note that most safety belts on school buses, even the smaller buses, are lap-belt-only safety belts that may not be used with belt positioning boosters. Refer to "Summary of Requirements to comply with the NC CPS Law and Recommendations for Maximum Safety in ANY VEHICLE" for recommendations.

**Recommendations for Transporting Pre-School Children on School Buses**

The National Highway Traffic Safety Administration (NHTSA) believes, and research confirms, that school buses are one of the safest forms of transportation in this country. Therefore NHTSA strongly recommends that all buses used to transport pre-school and school children be certified as meeting NHTSA's school bus safety standards. Using vans that do not meet the school bus standards to transport students could result in increased liability in the event of a crash.

The National Highway Traffic Safety Administration (NHTSA) further recommends that preschool age children are best transported in child restraints even on the larger school buses. If it is determined that a child must be transported in a child restraint on a bus, the NHTSA "Guidelines for the Safe Transportation of Preschool Age Children in School Buses" (February, 1999) should be followed. These guidelines are available on [www.buckleupnc.org](http://www.buckleupnc.org).

An additional resource is the "Guide for the Transportation of Preschoolers and Children with Disabilities for North Carolina Public Schools: Transportation Policies, Guidelines, and Best Practices," also available on [www.buckleupnc.org](http://www.buckleupnc.org).

**Additional State and Federal Regulations**

Federal regulations do not prohibit the use of vans by schools *per se*. Instead, federal regulations require that any new van with a capacity of more than 10 persons that is sold or leased for transporting children to or from school meet the safety standards applicable to school buses. Federal regulations apply only to the manufacture and sale/lease of new vehicles.

Head Start regulations require that children weighing 50 pounds or less must be restrained in height- and weight-appropriate child restraints. Programs transporting children to and from Head Start and Early Head Start programs must use school buses or "allowable alternate vehicles" by January 2006.

An "allowable alternate vehicle" is a vehicle designed for carrying eleven or more people, including the driver, that meets all the Federal Motor Vehicle Safety Standards applicable to school buses except those related to flashing lights and stop arms. Vans that do not meet the school bus standards are prohibited. Head Start transportation regulations are available on [www.buckleupnc.org](http://www.buckleupnc.org).

North Carolina Child Care Transportation standard NCAC 09.1001 covers NC child care centers and requires that all children less than 2 years of age to be transported in a child restraint, even on buses. Thus, child care centers transporting children less than age 2 on buses may need to retrofit the bus with belts in order to use child restraints for these children. Transportation standards for NC child care centers are available on [www.buckleupnc.org](http://www.buckleupnc.org).

**Summary of NC Restraint Requirements for Vehicle Types**

- ▶ No type of organization is exempt from the NC Child Passenger Safety Law, only types of vehicles.
- ▶ **Buses weighing more than 10,000 pounds:**
  - Are not required by Federal Standards to be equipped with safety belts and are exempt from the NC CPS law.
  - Organizations that provide transportation on large buses do not have to restrain children in safety belts or child restraints to comply with NC law.
  - Organizations that provide transportation on large buses may be required to restrain children in safety belts or child restraints to comply with applicable state, federal or program-specific regulations.
- ▶ **Buses weighing under 10,000 pounds:**
  - Are required to have safety belts.
  - Organizations that provide transportation on smaller buses are subject to and must comply with the NC CPS law.
- ▶ **Vans and mini-vans:**
  - Organizations that provide transportation on vans of any size are subject to and must comply with the NC CPS law.

**Summary of Requirements to comply with the NC CPS Law and Recommendations for Maximum Safety in ANY VEHICLE:**

- ▶ In positions equipped with lap and shoulder safety belts, restrain children:
  - In properly installed child restraints with harnesses if they weigh less than 40 pounds.
  - In belt positioning booster seats if they are both less than eight years old and weigh less than 80 pounds.
  - In properly fitted lap and shoulder belt if they are at least eight years old or if they weigh at least 80 pounds.
  - **RECOMMENDATION:** Continue to use booster seats until both the lap and shoulder belts fit correctly on the child.
- ▶ In positions equipped with just lap belts, and if there are no lap and shoulder belted positions available, restrain children:
  - In properly installed child restraints with harnesses if they weigh less than 40 pounds.
  - In properly fitted lap-only safety belts if they weigh 40 pounds or more.
  - **RECOMMENDATION:** Children over 40 pounds should be restrained by options other than just the lap belt if possible. These options may require additional installation in vehicles because they are anchored with top tether straps in addition to safety belts. Recommended options for children over 40 pounds in lap-belt-only positions include:
    - There are several models of restraints with harnesses that can be used for children heavier than 40 pounds.
    - There are harnesses of various types that can be used for children over 40 pounds (example: E-Z-On Products).
    - Retrofit shoulder belt kits are available for some older models of cars and vans. Check with the vehicle manufacturer for availability.

For further information contact:

**UNC Highway Safety Research Center**  
 800-672-4527 / 919-962-2202  
[www.buckleupnc.org](http://www.buckleupnc.org)  
[www.hsrc.unc.edu](http://www.hsrc.unc.edu)

For further information or to order brochures or other educational materials, contact:

**NC Governor's Highway Safety Program**  
 800-999-9676 / 919-733-3083  
[www.ncdot.org/secretary/GHSP](http://www.ncdot.org/secretary/GHSP)

**NC Department of Insurance  
 NC SAFE KIDS Buckle Up**  
 888-347-3737 / 919-661-5880  
[www.ncsafekids.org](http://www.ncsafekids.org)

# The North Carolina Seat Belt Law: Commonly Asked Questions



## What are the basic requirements of the North Carolina Seat Belt law?

- ◆ All drivers and front seat passengers ages 16 and older are covered by the seat belt law and must have a seat belt properly fastened about his or her body at all times when the vehicle is being driven on a street or highway.
- ◆ North Carolina's Graduated Driver Licensing law requires all vehicle occupants - regardless of their age or their seating position - to wear a seatbelt when riding with a driver younger than 18.
- ◆ Children less than age 16 are covered under the North Carolina Child Passenger Safety Law.
- ◆ All occupants of ANY age in ALL seating positions should ride buckled up to help protect all occupants. Unbuckled rear seat occupants can injure buckled up front seat occupants as well as themselves when they are thrown around or out of the car in a crash.

## What vehicles are covered?

- ◆ All "passenger motor vehicles" required by federal standards to be equipped with seat belts are covered. "Passenger motor vehicle" is defined as a motor vehicle designed for carrying ten or fewer passengers but excludes motorcycles, mopeds or trailers.
- ◆ All passenger cars manufactured after 1967 are required by federal law to have seat belts. Requirements for vans, pickup trucks and sport utility vehicles to be equipped with belts began with the models manufactured after 1971. There are no exemptions for vehicles registered in other states.

## What are the penalties for not complying with this law?

- ◆ Violators are issued tickets and are subject to a penalty of \$25.00 plus \$50.00 in court costs. Of course, the worst outcome of non-compliance would be a crash in which a driver or passenger is seriously injured or killed because of not being buckled up.

## If a passenger isn't buckled up, who gets the ticket?

- ◆ Drivers are responsible for themselves and for all children less than age 16 in the front or back

seat. Front seat passengers ages 16 and older are responsible for themselves and would get the ticket rather than the driver.

## Are both lap and shoulder belts required?

- ◆ The law requires the proper use of whatever seat belt system the seating position provides. Vehicles equipped with air bags also provide lap and shoulder belts that must be worn. Some vehicles have automatic shoulder belts with lap belts that have to be fastened manually. These manual lap belts must be used for compliance and for maximum protection.

## How is the law that covers children different?

- ◆ Children and youth less than age 16 are covered under the Child Passenger Safety Law. Children less than age 16 must be buckled up in the rear seat as well as the front.
- ◆ As of January 1, 2005, most children under age 8 and less than 80 pounds in weight must be in properly used child restraints or booster seats appropriate for their weight. Child restraints for children less than age 5 and less than 40 pounds must be installed in the rear seat if the vehicle has a passenger side front air bag. Children may be buckled in using a properly fitted seat belt at the age of 8 or when they weigh at least 80 pounds.

- ◆ A separate NC law prohibits children less than age 12 from riding in the open bed of a pickup truck unless there is an adult present supervising the child; if the child is secured in a seat belt installed in a manner approved by the Commissioner of motor vehicles; if an emergency exists, if the truck is being used in a parade or for agricultural purposes; or if the truck is being operated in a county with no incorporated area of a population greater than 3,500.

## My car doesn't have seat belts. Do I have to install them?

- ◆ Cars manufactured after 1967 and vans, pickup trucks and sport utility vehicles manufactured after 1971 are required by federal standards to have belts. Belts must be installed in these vehicles if the original seat belts have been removed. Belts do not have to be added to older models.
- ◆ Passenger vehicles, light trucks and vans brought in from other countries must be fitted with

belts if they were manufactured after the above dates but do not have seat belts in them.

**Our pickup truck has only three seat belts but there are four in our family. What do we do?**

◆ There is no safe way to carry more people than you have belts to accommodate. If room allows, extra belts can be installed to protect more people.

◆ There is no "more occupants than belts" exemption in the NC Seat Belt Law. If you have four people age sixteen or older and three belts, the fourth person is in violation of the law.

**Are employees required to wear their belts in company cars?**

◆ In most cases, yes. Vehicles with "commercial" or "farm" license plate that are being used for business purposes, delivery vehicles making frequent stops and not exceeding 20 mph, and those being used by a rural mail or newspaper carrier are exempt. Many employers, however, have seat belt use policies for their vehicles.

**What are valid medical exemptions? How do I get one?**

◆ The North Carolina Medical Society's Executive Council has stated that "medical exemptions to the state's seat belt law be granted only in extraordinary cases of medical necessity..." If a physician decides that a patient has an "extraordinary case of medical necessity" preventing his or her from wearing a seat belt, then a letter from the physician stating this situation and carried by the patient is needed.

**I'm too large for my seat belt to fit around me. What should I do?**

◆ Seat belt extenders are available for most domestic vehicles for a small fee. These extenders are 10 inch lengths of webbing with buckles on both ends to fit onto the belts already in the vehicles. Take the information on the seat belt label along with your vehicle to the parts department of your local dealer. Extenders are not interchangeable so go to the dealer for your particular vehicle. If you have any trouble getting service from the dealer, try another dealer or call

the customer assistance number listed in your owner's manual. Check your owner's manual for an explanation of these belt systems.

**Now that I'm pregnant, should I still wear my seat belt?**

◆ Yes, especially now. The greatest threat to the unborn child is death or serious injury to the mother, and a seat belt will help insure your survival in the event of a crash. When possible, both the lap and shoulder belt should be worn with the lap portion low and snug on the hips beneath the baby and the shoulder belt snug and above the baby.

**Can't seat belts actually cause injuries?**

◆ Yes, they can cause some injuries, especially in severe crashes. These injuries are usually limited to bruises and cracked collar bones and ribs - very minor injuries when compared to what often happens without the seat belt. It is important that belts be worn correctly to reduce the chance that they might injure you.

◆ Lap belts should be worn as low and snug as possible on the hips since belts that are worn high on the stomach can cause injuries.

◆ Shoulder belts must also be worn snugly across the shoulder and chest. Never wear a shoulder belt with more than an inch of space between your chest and the belt. Too much slack will allow your head to go too far forward in a crash. If the shoulder belt rubs against your neck and is uncomfortable, try adjusting your sitting position or the position of the vehicle seat to get a proper fit. Cloth comfort sleeves can be placed on the shoulder belt to make it more comfortable.

◆ Do not place the shoulder belt behind your back or under your arm. With the shoulder belt behind the back, your head will be thrown forward to strike the dashboard, windshield, or the air bag. As with the belts behind the back, shoulder belts under the arm do not hold your head back away from danger. In addition, the belt under the arm can fracture ribs and cause serious internal injuries.

For further information contact:

UNC Highway Safety Research Center  
800-672-4527 / 919-962-2202  
[www.buckleupnc.org](http://www.buckleupnc.org)  
[www.hsrb.unc.edu](http://www.hsrb.unc.edu)

For further information or to order brochures or other educational materials, contact:

NC Governor's Highway Safety Program  
800-999-9676 / 919-733-3083  
[www.ncdot.org/secretary/GHSP](http://www.ncdot.org/secretary/GHSP)

NC Department of Insurance  
NC SAFE KIDS Buckle Up  
800-634-7854 / 919-661-5880  
[www.ncsafekids.org](http://www.ncsafekids.org)

## Requirements of the North Carolina Children in Back of a Pickup Truck Law

### What are the basic requirements of the North Carolina Pickup law?

On January 1, 1995, a separate NC law went into effect that prohibits children less than age twelve from riding in the open bed of a pickup truck. An open bed or open cargo area is a bed or cargo area without permanent overhead restraining construction.

### What is a “permanent overhead restraining construction”?

What constitutes a permanent overhead restraining construction has never been defined by the NC Legislature or the courts. The generally accepted interpretation is that this is a structure welded or bolted to the vehicle.



Note, however, that “permanent overhead restraining constructions” may help to reduce ejection from the vehicle but do not in fact protect occupants as seat belts and child safety seats do. Riders in camper shells and other similar structures are also exposed to a greater risk of carbon monoxide poisoning.

### What are the exemptions to this law?

There are six exemptions to this law: The provisions for proper securement of children do not apply:

1. If an adult is present in the bed or cargo area of the vehicle and is supervising the child;
2. If the child is secured or restrained by a seat belt manufactured in compliance with Federal Motor Vehicle Safety Standard No. 208, installed to support a load strength of not less than 5,000 pounds for each belt, and of a type approved by the Commissioner;
3. If an emergency situation exists;
4. If the vehicle is being operated in a parade pursuant to a valid permit;
5. If the vehicle is being operated in an agricultural enterprise; or
6. If the vehicle is being operated in a county which has no incorporated area with a population in excess of 3,500.

[Note: Counties with <3,500 population: Alexander, Alleghany, Ashe, Avery, Bertie, Camden, Caswell, Cherokee, Clay, Currituck, Duplin, Franklin, Gates, Graham, Green, Hyde, Jackson, Jones, Macon, Madison, Mitchell, Montgomery, Northhampton, Pamlico, Pender, Perquimans, Polk, Swain, Tyrrell, Warren, Yadkin, and Yancey.]

### What will happen to me if I don't comply with this law?

Violators are issued tickets and are subject to a penalty of \$25.00. Violations of this law have been defined as "infractions" and do not incur court costs, driver license points or insurance surcharges. Of course, the worst outcome of non-compliance would be a crash in which a child is seriously injured or killed because of not being properly buckled up.

### Can safety seats be safely and legally used on side facing-seats in a truck cab?

This is illegal since the NC Child Passenger Safety Law requires use of the restraint system according to the manufacturer's instructions, all of which specify that the safety seats should not be used in side-facing seats.

### For further information, contact:

The University of North Carolina Highway Safety Research Center  
CB# 3430  
Chapel Hill, NC 27599  
919-962-2202 or (in NC) 800-672-4527

**PREVIEW COPY**

# Growing Up Buckled Up in North Carolina



There are differences between what is LEGAL and what is RECOMMENDED for buckling up children.

## Protecting Children in Crashes Requires 3 Important Steps:

### 1. The restraint must be right for the size and age of the child.

- ▶ Use rear-facing child restraints (CRs) for children until at least 1 year of age AND at least 20 pounds. Most children reach 20 pounds before age 1 and need to be in a rear-facing convertible CR approved for heavier babies. Keep children facing the rear as long as possible.
- ▶ Use forward-facing CRs with a harness and/or shield for children over 1 year old. Use the harness and/or shield until it is outgrown, usually 40 pounds. There are a few models that have harnesses or shields that can be used over 40 pounds.
- ▶ Use belt-positioning booster seats that make a lap and shoulder belt combination fit correctly for children who have outgrown their harness type CR until they are large enough for the seat belt to fit correctly.
- ▶ Add-on shoulder belt adjusters are not recommended since they are not covered by any Federal standards and may, in fact, do more harm than good.
- ▶ Never tuck the shoulder belt under the arm or behind the back. Both of these common practices are dangerous and illegal.
- ▶ Use seat belts for older children only when they are large enough for the belt to fit correctly. Usually, this will be about 8 years old and about 80 pounds. To tell if a child is big enough to use just the vehicle lap and shoulder belt, ask the following questions: 1) can he sit all the way back against the auto seat, 2) do his knees bend comfortably at the edge of the auto seat, 3) does the shoulder belt cross his shoulder between his neck and arm, 4) is the lap belt positioned low and touching his thighs, and 5) will he stay seated like this for the whole trip? If the answer is "no" to any of these questions, a belt-positioning booster seat is needed for the best crash protection.
- ▶ Whenever possible, keep children younger than age 13 buckled up in a rear seat of the vehicle.
- ▶ CRs older than 10 years should not be used. Any child seat, regardless of age, that has been in a severe crash should be replaced.

### 2. The child must be buckled correctly into the restraint .

- ▶ The type of harness or shield must be appropriate for the size of the child. Harnesses with shields do not fit small infants well.
- ▶ All parts of the harness must be present and in good condition.
- ▶ In general, the harness straps should be at or below shoulder level for rear-facing restraints and at or above shoulder level for forward-facing restraints. Refer to the CR manufacturer's instructions to be sure.

NC has three occupant restraint laws. Effective as of January 1, 2005, their basic requirements are that...

- ▶ All drivers and front seat passengers, regardless of age, must be properly buckled up.
  - ▶ All children less than 16 years old must be buckled up in either the front or back seat.
  - ▶ As of January 1, 2005, children younger than age 8 and who weigh less than 80 pounds must be properly secured in a child restraint (CR).
  - ▶ Car booster seats can be used for older and larger children if lap and shoulder combination belts are available.
  - ▶ Lap-only seat belts can be used for children over 40 pounds if no lap and shoulder combination seat belt is available. Belt-positioning booster seats may not be used with just a lap belt.
  - ▶ CRs for children less than age 5 and less than 40 pounds must be installed in the rear seat in vehicles with active passenger-side air bags.
  - ▶ When a child reaches age 8 (regardless of weight) OR 80 pounds (regardless of age), a correctly fitted seat belt may be used instead of a CR to restrain the child.
  - ▶ Placing the shoulder belt under a child's (or adult's) arm or behind the back is dangerous and is illegal.
  - ▶ Children less than age 12 are prohibited from riding in the open bed of a pickup truck or other open cargo area.
  - ▶ Drivers are responsible for obeying these laws.
  - ▶ The penalty for not complying with the Child Restraint/Booster Seat law is 2 driver license points, a \$25 fine and \$100 court costs.
- ▶ The harness must be as snug as possible without pressing into the child's skin and causing physical discomfort. You should not be able to pinch the strap to make a fold in the harness webbing.

### 3. The restraint must be correctly installed in the vehicle.

- ▶ NEVER install a rear-facing restraint in front of an active air bag.
- ▶ The rear seat is safer for children than the front seat. Whenever possible, child restraints should be installed in the center-rear seat.
- ▶ Infants less than a year in age should ride in a restraint that faces the rear of the car. Follow the CR's instructions for the correct recline angle.
- ▶ The vehicle seat belt must be routed correctly through or around the restraint according to the CR's instructions.
- ▶ LATCH (Lower Anchors and Tethers for Children) is a new system that can make CR installation easier and without using seat belts. LATCH is found on most CRs and vehicles manufactured after September 1, 2002.
- ▶ The CR must be installed tightly in the vehicle. To check, hold the shell of the CR at the seat belt path (where the seat belt goes through the CR or where it would go through if not using the lower LATCH attachments) and pull toward the front of the car and side-to-side. There should be no more than 1 inch of movement in either direction.
- ▶ The seat belt or LATCH attachments must be locked in order to stay tight. Locking clips are needed on some seat belts. Check the vehicle owner's manual to be sure.
- ▶ Top tethers can make most front-facing restraints work better. Follow instructions to install and use tether straps whenever possible.

For further information or to order brochures or other educational materials, visit [www.buckleupnc.org](http://www.buckleupnc.org) or contact:

UNC Highway Safety Research Center  
800-672-4527 / 919-962-2202  
[www.hsrc.unc.edu](http://www.hsrc.unc.edu)

NC Governor's Highway Safety Program  
800-999-9676 / 919-733-3083  
[www.ncdot.org/secretary/ghsp/](http://www.ncdot.org/secretary/ghsp/)

NC Dept. of Insurance Safe Kids Buckle Up  
800-634-7854 / 919-661-5880  
[www.ncsafekids.org](http://www.ncsafekids.org)

**PREVIEW COPY**



## Buyer's Guide to Used Child Restraints

*Condition should come before price when shopping for a used child restraint.*

*The price of a child restraint should not be used as the main determining factor when selecting a child restraint to use. The most expensive model is not necessarily safer than a basic inexpensive model. On the other hand, the low cost of a used child restraint (or no cost for a hand-me-down) is not worth it if you end up with an unsafe seat.*

*Parents and other caregivers can obtain good, safe second-hand child restraints but should use caution in selecting one and must decide if the lower cost of a used restraint is really worth it. Most of the newer models are more convenient and easier to use than older models. An inexpensive but hard-to-use restraint may not be a bargain over time. Without a doubt, an unsafe child restraint is no bargain at all!*

*When deciding whether or not to purchase a second-hand child restraint or to use any other "hand-me-down," check to be sure that:*

- The child restraint has a full set of labels giving the manufacturer, model number, date of manufacture and statement that it complies with "all applicable Federal Motor Vehicle Safety Standards." (Restraints without these important labels can not be identified for sure, may not be safe, and should not be used!)
- The restraint has not passed the expiration date indicated on the label or shell or, if there is no expiration date, that it is less than ten years old. (Some models are labeled with an expiration date, some manufacturers set a six year limit, and any restraint older than ten years should not be used!)
- The restraint has not been recalled or, if there was a recall issued on it, that any defects have been corrected. (To find out for sure, call the manufacturer.)
- You have a copy of the manufacturer's instruction book, not just the basic installation and use labels. (If you don't, call the manufacturer to request a copy.)

- The restraint has all its parts: harness straps and/or shield, retainer clip, padding, tether strap, and bolts. (If not, do not use the restraint until the replacement parts are obtained and properly installed.)
- The restraint is free from cracks, bends, or breaks in the frame or shell. (If damaged, the restraint may not hold up in a crash and should not be used!)
- The harness straps are not worn or frayed. (If so, the restraint is not safe and should not be used until a replacement harness is obtained from the manufacturer and properly installed!)
- The buckle area is free from rust and the buckle latch mechanism fastens securely, remains fastened, and unfastens smoothly. (If not, the restraint is not safe and should not be used until a replacement buckle is obtained and properly installed!)
- The restraint has never been involved in a serious crash. (Crash-involved restraints may be weakened even if there is no apparent damage. If so, the restraint may not be safe and should not be used!)

*Developed by the North Carolina State Highway Patrol,  
Buckle In Baby Safety Program - July 2001*

*Adapted by the University of North Carolina  
Highway Safety Research Center - March 2004  
800-672-4527 (in NC) ♦ 919-962-8721 ♦ buckleupnc.org*

Check to be sure...

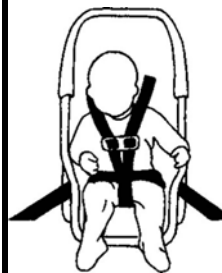

- ✓ Labeled with manufacturer, model, and date
- ✓ Less than 10 years old
- ✓ No uncorrected recalls
- ✓ All manufacturer's instructions
- ✓ All parts present
- ✓ Frame, shell and all parts are in good condition, working smoothly
- ✓ Has not been used in a crash

Prospective buyers should be able to answer "yes" to all seven items. If not, the restraint is not a safe buy.

**PREVIEW COPY**



## Recommendations for Replacement of Crash-Involved Safety Belts & Child Restraints

Airbags, safety belts, and child restraints (CRs) are generally considered "one time use" products. After a crash they may need to be replaced. Without a doubt, airbags and pretensioners used with some belt systems must be replaced if they are activated during a crash.

Vehicle manufacturers also recommend that safety belts in use in a crash be replaced except in minor crashes. Some vehicle manufacturers suggest that the safety belts should be inspected by a service technician after any type or severity of collision. Contact your vehicle manufacturer's Customer Service for their guidelines and recommendations.

Most child restraint manufacturers recommend replacement of their child restraints after any crash. Contact your child restraint manufacturer's Customer Service for their guidelines and recommendations.

The National Highway Traffic Safety Administration (NHTSA) recommends that a child restraint always be replaced if it is involved in a moderate to severe crash. In general, automobile collision insurance should cover replacement of airbags, safety belts, and child restraints.

To determine if a crash is severe enough to warrant CR replacement, NHTSA advises parents/caregivers to use the following criteria:

- 1) Does a visual inspection of the child restraint (CR), including inspection under any easily movable seat padding, reveal any cracks or deformities that might have been caused by the crash?  
 Yes: Replace CR<sup>1</sup>       No: Continue to next question
- 2) Did the vehicle in which the CR was installed have to be towed from the scene of the crash?  
 Yes: Replace CR<sup>1</sup>       No: Continue to next question
- 3) Was the vehicle door nearest the CR damaged?  
 Yes: Replace CR<sup>1</sup>       No: Continue to next question
- 4) Were there injuries to any of the vehicle occupants?  
 Yes: Replace CR<sup>1</sup>       No: Continue to next question
- 5) Did the air bags in the vehicle (if any) deploy?  
 Yes: Replace CR<sup>1</sup>       No: Replacement of CR not warranted<sup>2</sup>

<sup>1</sup>If the answer is "Yes" to ANY of the above questions, the crash is considered to be serious enough to warrant replacement of the child restraint.

<sup>2</sup>If the answer is "No" to ALL of the above questions, the crash is NOT considered to be serious enough to warrant replacement of the child restraint.

For further information contact: <b>UNC Highway Safety Research Center</b> 800-672-4527 / 919-962-2202 <a href="http://www.buckleupnc.org">www.buckleupnc.org</a> <a href="http://www.hsrb.unc.edu">www.hsrb.unc.edu</a>	For further information or to order brochures or other educational materials, contact: <b>NC Governor's Highway Safety Program</b> 800-999-9676 / 919-733-3083 <a href="http://www.ncdot.org/secretary/GHSP">www.ncdot.org/secretary/GHSP</a>	<b>NC Department of Insurance</b> <b>NC SAFE KIDS Buckle Up</b> 800-634-7854 / 919-661-5880 <a href="http://www.ncsafekids.org">www.ncsafekids.org</a>
--------------------------------------------------------------------------------------------------------------------------------------------------------------------------------------------------------------------------------------	--------------------------------------------------------------------------------------------------------------------------------------------------------------------------------------------------------------------------------------------------------	-----------------------------------------------------------------------------------------------------------------------------------------------------------------

**PREVIEW COPY**

Vehicles manufactured on or after September 1, 1995 (1996 model year) must be equipped with belt systems that secure safety seats without the need for locking clips or other additional hardware. Check owner's manual as well as checking lap/shoulder belts for switchable ALR/ELR retractors, lightweight locking latch plates, or switchable latch plates on late model vehicles. Newer systems introduced in response to this requirement are indicated by a "\*\*"

TYPE OF BELT	CHARACTERISTICS / HOW TO LOCK	COMMENTS ON USE WITH CHILD SAFETY SEATS (CSS)
<b>LAP BELT ONLY</b>		
<b>Manually Adjusting</b>	Insert latch plate in buckle and pull on free end to tighten. Belt stays locked as long as belt webbing and latch plate are parallel. Tilt latch plate to release webbing to loosen.	Generally easy to use. Latch plate must be at correct angle to stay locked. If belt will not stay tight when buckled and reasonable force applied. 1) flip latch plate upside down before buckling, or 2) Shorten buckle end of belt by twisting belt webbing as much as needed to correct the latch plate angle.
<b>Automatic Locking Retractor (ALR)</b>	Pull belt from retractor, will automatically lock after retracting about a quarter inch. Remains locked and cannot lengthen belt until belt rewinds completely.	Relatively easy to use. Push safety seat into vehicle seat while pushing belt back into retractor. Belt will automatically stay locked.
<b>Emergency Locking Retractor (ELR)</b>	Belt moves freely in and out of the retractor during normal driving. Locks only when the vehicle or occupant moves very suddenly. <b>PULL SLOWLY AND GENTLY TO TEST.</b> Types of ELR's include:	
<b>Vehicle Sensitive ELR</b>	Belt locks only if there is sudden movement of the vehicle. Belt will <u>not</u> lock when webbing is pulled on sharply. All ELRs are vehicle sensitive	<b>DO NOT USE AS IS.</b> ELR retractors will release locking mechanism when allowed to rewind about 1/4 to 1/2 inch. Solutions: 1) Use another position, 2) Use belt-shortening locking clip from Ford or Toyota or other vehicle manufacturer to shorten belt enough to stay tight around seat when fully extended. May need more than one clip. Difficult and inconvenient to use. 3) Replace with manually adjusting belt for long term use.
<b>Belt Sensitive ELR</b>	Some ELR belts also lock when there is sudden movement of the belt itself. Tug sharply on the belt webbing to test.	NOTE: Belt sensitive ELR may be confused with ALR unless belt is pulled <u>very gently</u> out of the retractor.
<b>Switchable ELR/ALR</b>	Works as ELR for use by adults. Converts to ALR for use with CSS. Converts back to ELR for use by adults and larger children.	Easy to use. Be sure belt locks in ALR mode. Most switch when belt is fully extended to engage the ALR. Other types convert by flipping a switch on the retractor (check owner's manual). Route belt through CSS and buckle, switch retractor to ALR and use like ALR above.
<b>LAP/SHOULDER BELT COMBINATIONS</b>		
<b>Separate Lap and Shoulder Belts</b>	Most often found on older cars. Lap and shoulder belts are two different belts with separate buckles or latch plates interlock before buckling.	May or may not be able to use. Ignore shoulder belt and determine what type of lap belt is present. Can be used with safety seat if lap belt is not ELR.
<b>Sewn-on (Fixed) Latch Plate</b>	Lap and shoulder portions each have their own retractors with each belt sewn onto latch plate.	May or may not be able to use. Ignore shoulder portion. May be used if lap belt is ALR or switchable ELR/ALR. If lap belt appears to be ELR, check to see if it will convert to ALR.**
<b>Continuous Loop Lap/ Shoulder Retractor</b>	The length of the belt is controlled by the shoulder belt retractor. Types of latch plates found on continuous loop belts include:	Generally, the lap belt portion is fixed to the vehicle [is not on a retracto].
<b>Locking Latch Plate</b>	Belt webbing is threaded through and around a locking bar in the latch plate that holds lap portion tight when lap belt is parallel to latch plate.	Generally good to use with seat. Thread lap belt through belt routing location (shoulder portion will follow lap belt), then pull on shoulder belt to tighten. Check to see that lap belt does not loosen due to improper angle of latch plate. If belt will not stay tight when pulled on: 1) flip latch plate upside down before buckling. 2) shorten buckle end of belt by twisting belt webbing as much as needed to correct the latch plate angle, or 3) use locking clip.

TYPE OF BELT	CHARACTERISTICS / HOW TO LOCK	COMMENTS ON USE WITH CHILD SAFETY SEATS (CSS)
Lightweight Locking Latch Plate **	Latch plate slides freely along webbing unless belt is buckled and webbing pulls tightly enough to engage latch plate locking mechanism. Latch plate may only "cinch" rather than lock and release when enough pressure is applied.	May or may not work well "as is" with safety seats. Route belt through correct path, buckle and tighten. Test installation by pulling on the seat at the belt path with a reasonable amount of force. If belt loosens: 1) Flip latch plate upside down before buckling. 2) shorten buckle end of belt by twisting belt webbing, or 3) use locking clip.
Free-Sliding Latch Plate with ELR Retractor	Belt webbing threaded through slot in latch plate. Webbing can be pulled back and forth through latch plate after being buckled. Allows lap portion to loosen after seat is buckled in.	<b>LOCKING CLIP MUST BE USED TO KEEP LAP BELT TIGHT.</b> Regular locking or belt-shortening clip can be used. Route belt through correct path, buckle and tighten. Grasp and hold both portions of webbing directly behind latch plate & unbuckle. Thread locking clip on belt as close to latch plate as possible (within 1 inch) & re-buckle. Should be difficult to re-buckle if belt is made tight enough.
Free-Sliding Latch Plate with Switchable ELR to ALR Retractor **	Works as ELR for use by adults. Converts to ALR for installing CSS.	Relatively easy to use. Be sure belt locks in ALR mode. Most switch when belt is fully extended to engage the ALR. Other types convert by flipping a switch on the retractor (check owner's manual). Belt will automatically stay locked. Route belt through CSS and buckle, switch retractor to ALR, push safety seat into vehicle seat while pushing belt back into retractor. NOTE: May need to reinstall with less force applies or use locking clip if tension on shoulder belt pulls too hard and tilts the CSS to the degree that it is pulled off of the cushion on one side.
Switchable Latch Plate**	Switch on latch plate converts it from a free-sliding to a locking latch plate.	Follow vehicle owner's manual for switching latch plate from free-sliding to locking. Follow "Comments On Use" for "Lap Belt Only Locking Latch plate" above.
<b>AUTOMATIC RESTRAINTS</b>		
Automatic Shoulder Belt with Knee Bolster	Shoulder belt is fixed to the door. Belt closes over occupant when door is closed. No lap belt is provided. Knee bolster (padded lower dashboard) stops forward movement.	<b>CAN NOT BE USED TO INSTALL CSS.</b> No lap belt is provided. Must be installed in rear seat.
Automatic Shoulder Belt with Manual Lap Belt	Shoulder belt is fixed to the door or on a motorized track above door frame. Belt closes over occupant when door is closed or ignition is turned on. Lap belt must also be used, but must be fastened manually.	<b>MAY NOT BE ABLE TO USE AS IS.</b> Shoulder belt must be disconnected. Majority of lap belts are on an emergency locking retractor. Check owner's manual for model specific information. If lap belt is ELR: 1) Install safety seat in rear seat, 2) Check to see if auxiliary locking lap belt is available from dealer, or 3) Use belt-shortening clip.
Automatic Lap and Shoulder Belt	Lap and shoulder belts are both on retractors inside door. Occupant slides under belts when getting in and both belts close over occupant when door is closed. Primarily on General Motors vehicles.	<b>DO NOT USE AS IS.</b> Lap belt cannot be threaded through safety seat with door open plus the lap belts are on emergency locking retractors. Options are to: 1) Install safety seat in rear seat, or 2) Have auxiliary lap belt designed for use with CSS installed by dealer (free part and service for GM vehicles through local dealers).
Air Bags (Supplemental Restraint Systems)	Inflates instantly in frontal crashes over 12-15 mph. Positions covered by air bags have manual lap/shoulder belts. Owners can petition NHTSA to receive permission for a dealer to install an on/off switch. Petitions generally granted only when use of front seat absolutely necessary	<b>DO NOT INSTALL REAR-FACING SEATS IN AN AIR BAG EQUIPPED POSITION. MUST USE REAR SEAT FOR CHILD UNDER 20 LBS. AND LESS THAN A YEAR OLD. INSTALL FRONT-FACING SEATS IN AN AIR BAG POSITION ONLY IF ABSOLUTELY NECESSARY.</b> For front-facing seats, check owner's manual for recommendations for specific vehicles. May be allowed by vehicle manufacturer for front-facing safety seat, but use with extreme caution and move the vehicle seat back as far as possible. Air bag equipped vehicles have manual belts. If installation of safety seat is allowed, refer to "Lap/Shoulder Belt Combinations" section above for comments on use.

How tight is tight enough? Child safety seats should be installed so that there is no more than one inch of movement front to back and side to side when tested at the belt path. A secure installation can be achieved without causing damage to the vehicle or CSS and without using brute force.

## Child Occupant Protection Glossary

<b>3-point CR harness:</b>	A restraint system with three attachment points: two at the shoulder and one between the legs.
<b>3-point safety belt:</b>	A safety belt with both a lap and a shoulder portion that has three attachment points (one at the shoulder and two at the hips).
<b>5-point CR harness:</b>	A child restraint harness with five attachment points: two at the shoulder, two at the hips, one between the legs.
<b>Air bag:</b>	A passive restraint system that automatically deploys during a crash to act as a cushion for the occupant. It creates a broad surface on which to spread the forces of the crash, in order to reduce head and chest injury. It is considered a "supplementary" system to the lap/shoulder belt because it enhances their protective action in frontal collisions. Also known as SRS-supplemental restraint system; SIR-supplemental inflatable restraint; SIPS-side impact protection system; IC-inflatable curtain.
<b>Armrest:</b>	A U-shaped bar encircling the child on older models of child restraints. Not a shield. Not connected to the harness system. Not part of the system intended to restrain the child. No longer allowed on child restraints meeting FMVSS 213.
<b>Automatic locking retractor (ALR):</b>	A safety belt retractor that locks maintaining fixed length during use.
<b>Automatic restraint:</b>	A type of passive restraint system that requires no action by the user. Includes shoulder/lap or shoulder belts that wrap "automatically" around the occupant; air bags.
<b>Belt anchor points:</b>	Fixed location where the safety belt is anchored to the vehicle structure.
<b>Belt path or route:</b>	The place where the safety belt passes around or through the child restraint.
<b>Belt positioning booster seat (BPB):</b>	A crash tested platform that raises the child so that the required lap and shoulder belts fit correctly. All BPBs act as pre-crash positioning devices and must be used with lap/shoulder (L/S) belts. BPB models may have high backs, or be backless.
<b>Belt-shortening clip:</b>	A heavy duty locking clip intended for use to shorten lap belts around a child restraint. Not to be confused with the standard locking clip that comes with a car seat. Must be purchased or ordered from vehicle manufacturer.
<b>Best practice:</b>	Recommendations that provide the safest way to travel for a child of certain age, size, and physical tolerances. Best practice recommendations may conflict with real world situations.
<b>CPS:</b>	Child passenger safety.
<b>Child Restraint (CR), Child Restraint System (CRS), or Child Restraint Device (CRD):</b>	A device or system that is specially designed to provide infant/child crash protection. A general term for all sorts of devices including those that are vests or car beds rather than seats.
<b>Child Safety Seat (CSS):</b>	Another commonly used term for a child restraint.
<b>Children with special transportation needs:</b>	Children whose physical or behavioral conditions make the use of specially designed, restraint systems necessary.

## Child Occupant Protection Glossary

<b>Compliance tests:</b>	Rigorous crash tests done to assure that manufacturers meet required federal standards (in this case, FMVSS 213). Established by NHTSA.
<b>Continuous loop lap/shoulder belt:</b>	A three-point belt that uses one continuous strip of webbing that slides through the latch plate. It is connected at one end to the vehicle at the anchor point and the other to a retractor system.
<b>Convertible child restraint:</b>	A child restraint that "converts" from rear-facing for infants to forward-facing for children up to at least 40 pounds. (New seats have higher weight limits.)
<b>Combination child seat / booster:</b>	A type of forward facing child restraint that is used with an internal harness system to secure a child to 40 pounds or more and then, with removal of the internal harness, is used as a high back belt positioning booster seat.
<b>Crush zone:</b>	The energy absorbing capability of the vehicle to reduce injury to the occupants.
<b>Emergency locking retractor (ELR):</b>	A retractor on a safety belt system that locks in response to rapid deceleration of the vehicle. ELRs respond to pressure applied to the belt or the sudden change in motion of the vehicle or both.
<b>Excursion:</b>	The distance traveled by an occupant or test dummy in the direction of impact during a crash.
<b>FAA approval:</b>	Certification that the child restraint meets the compliance test (within FMVSS 213) that is required for use on aircraft.
<b>FMVSS 213:</b>	Federal Motor Vehicle Safety Standard that pertains to all restraint systems intended for use as crash protection in vehicles for children up to 65 pounds.
<b>FMVSS 225:</b>	Federal Motor Vehicle Safety Standard that pertains to the standardized vehicle anchorage systems (upper and lower) that are independent of the vehicle seat belts.
<b>Foam Noodles:</b>	The solid core noodles commonly sold to be used by children in pools. These can be used to position the rear-facing child restraint to the correct angle.
<b>Forward facing child restraint:</b>	A restraint system that is intended for use only in the forward facing position for a child at least age 1 and at least 20 lbs.
<b>Frontal collision / impact / crash:</b>	An impact at the front end of the vehicle. The most common and usually the most severe type of collision.
<b>Gross misuse:</b>	The most flagrant CR errors. Those that completely negate the intended effect of the child restraint. These types of misuse are often visible from outside the vehicle.
<b>Harness retainer clip:</b>	A plastic (sometimes cloth) tie or clasp that holds the shoulder straps close together over the child's chest at armpit level. Pre-crash positioning device intended to keep harness straps in position on the shoulders.
<b>Head excursion:</b>	The distance forward that the occupant's head travels during an impact. An element regulated by FMVSS 213.
<b>Incompatibility:</b>	The ways in which motor vehicle seats, seat belts, and other elements impede the correct use of child restraints and vice versa.

## Child Occupant Protection Glossary

<b>Infant only restraint:</b>	A child restraint system designed for use only by a baby (usually weighing less than 17 - 22 pounds) in a rear facing or flat position.
<b>Integral (integrated) child seat:</b>	A child sized forward facing restraint or booster built into a vehicle seat. Some have a full harness and hold children over 20 pounds. Others are belt positioning boosters for use with L/S belts.
<b>Lap belt:</b>	A safety belt anchored at two points for use across a vehicle occupant's thighs/hips.
<b>Lap/shoulder (L/S) belt:</b>	A safety belt that is anchored at three points and restrains the vehicle occupant at the hips and across the shoulder. Also referred to as a combination L/S belt.
<b>LATCH):</b>	Lower Anchors and Tethers for CHildren (new acronym for standardized vehicle anchorage system).
<b>Latch plate:</b>	The part of the buckle mechanism that slides into the buckle. Usually the part that effects the length of the belt webbing.
<b>Lateral collision/impact:</b>	An impact into the side of a vehicle. Current occupant protection systems offer little protection in lateral impacts. Side air bag systems afford increased head and upper body protection in lateral crashes.
<b>Locking clip:</b>	A flat H-shaped metal item intended to clip belt webbing together at a free sliding latch plate in order to prevent the webbing from sliding through. A pre-crash positioning device only. Not to be used as a belt shortening clip.
<b>Locking latch plate:</b>	A latch plate that holds the lap belt snug after it has been adjusted.
<b>Manual safety belt:</b>	A seat belt that must be fastened and adjusted by the occupant.
<b>Morbidity:</b>	Non-fatal injuries or illnesses.
<b>Mortality:</b>	Fatal injuries or illnesses.
<b>National Highway Traffic Safety Administration (NHTSA):</b>	The federal agency that regulates motor vehicles and products such as child restraints. It also promotes safety.
<b>Noodle:</b>	See "Foam noodle"
<b>Passive occupant protection:</b>	Features of the vehicle that lessen the injury to the occupant without any action taken by the occupant.
<b>Primary prevention:</b>	Stopping an incident before it happens or preventing a resultant injury from an incident that has already occurred.
<b>Rebound:</b>	Reactive motion in the opposite direction after initial impact has occurred.
<b>Recalls:</b>	Actions to correct problems or deficiencies once products have been distributed or sold. Manufacturers must offer free repairs or replacement for products recalled for violations of safety standards.
<b>Retractor:</b>	A mechanism that rolls up the unused webbing of the safety belt when it is not in use and takes up slack around the user.

## Child Occupant Protection Glossary

<b>Retrofitted shoulder belt:</b>	A shoulder belt that is added to an existing vehicle belt system. Most often in the rear seat outboard positions. Most manufacturers make kits for older model vehicles.
<b>Safety belt:</b>	The webbing, anchor, and buckle system that restrains the occupant in the vehicle. A seat belt.
<b>Seat bight:</b>	The intersection between the bottom vehicle seat cushion and the back cushion. The seat crack.
<b>Secondary prevention:</b>	Minimizing injury to the body after an incident has occurred.
<b>Sewn-on latch plate:</b>	A latch plate on a lap belt or a lap/shoulder belt that has the webbing permanently stitched in place.
<b>Shield booster seat:</b>	A platform that raises the child and positions a small convex shield across the lap and lower abdomen to restrain the child. A vehicle lap belt restrains the booster seat. Some models have removable shields and convert to BPBs.
<b>Shell:</b>	The molded plastic structure of the child restraint. In some models, the shell is attached to or reinforced by a metal frame.
<b>Shoulder belt adjusters:</b>	Devices (some built in and some add-ons) that can be used to reposition shoulder belts so they fit across the shoulder rather than across the neck.
<b>Shoulder harness slots:</b>	Slots in the back of the child restraint through which shoulder straps are routed.
<b>Sliding latch plate:</b>	A latch plate that moves freely on a continuous loop of belt webbing.
<b>Submarine:</b>	The motion of a body during a crash under certain conditions. The body slides, legs first, often causing the lap belt to ride up onto the abdomen.
<b>Switchable (ALR/ELR) retractor:</b>	A retractor that usually functions as an ELR or can be transformed into an ALR to secure a child restraint.
<b>T-shield:</b>	Part of the restraint system in a CR. A roughly triangular or "T" shaped pad that is attached to the shoulder harness, fits over the child's abdomen and hips, and buckles between the legs.
<b>Tether anchor hardware:</b>	The kit or set of hardware used to secure the tether anchor bracket at the designated anchor point in the vehicle. The tether strap and hook attach directly to the anchor bracket.
<b>Tether strap:</b>	A piece of belt webbing that anchors the top of the CR to the vehicle frame. It keeps the restraint from tipping forward on impact and can provide an extra margin of protection. Can be optional or factory installed.
<b>Tray shield:</b>	Part of the restraint system in a CR. A wide, curved padded surface that swings down around the child's body and is attached to shoulder harness and crotch buckle. It looks like a padded armrest, but is an integral part of the harness system. Often (erroneously) perceived by parents as "safer" than a 5-point harness alone.
<b>Turn-around time:</b>	The point at which the young child's body has developed enough so he or she can be turned from rear facing to forward facing in the vehicle. Also, the weight designated by the manufacturer at which the convertible restraint should be turned to face forward.

## Child Occupant Protection Glossary

---

<b>Vest:</b>	A child restraint system that has shoulder straps, hip straps, (and sometimes) a crotch strap. Must meet the same crash standards as a CRS.
<b>Whiplash injury:</b>	An injury to the neck usually caused by sudden whipping of the head backward during a rear impact collision.

---

**PREVIEW COPY**

**PREVIEW COPY**

## English to Spanish Glossary

English Word(s)	Spanish Translation
#2 Lead Pencil	Lápiz de grafito #2
“Smart” air bags	Bolsas de aire “inteligentes”
5-point harness	Arnés de 5 puntos
Abdomen	Abdomen
Additional padding	Forros acolchonados adicionales
Adult vehicle occupant	Pasajero adulto
Affordability	Habilidad para pagarlo
After market products	Productos hechos después de la fabricación original
After market products	Productos hechos posteriormente
Air bag deployment	Despliegue de la bolsa de aire
Air bags	Bolsas de aire
Amount of slack in the seat belt	Cantidad de soltura de la correa del asiento
Anchor plate	Plancha del ancla
Anchor strap	Correa de anclar
Anchorage systems	Sistemas de anclaje, sistemas para anclar
Anchors	Anclas
Armpit level	Nivel de la axila
As tightly as possible	Tan apretadamente como sea posible
Asymmetrical	Asimétrico
Automatic locking retractor (ALR)	Retractor de agarre automático
Automatic restraint system	Sistema de restricción automático
Automatically lock	Agarrarse automáticamente
Automobile crashes	Choques automovilísticos
Automobile manufacturers	Manufactureros (o fabricantes) de automóviles
Being thrown out of the car	Ser arrojado del carro
Belt	Correa
Belt path	Trayectoria del cinturón
Belt shortening clip	Broche para acortar la correa
Belt-positioning booster seat	Asiento elevado ajustado con correas
Bench seat	Asiento de automóvil de banqueta (asiento largo)
Brush against (To)	Rozar
Bucket seat	Asiento de automóvil deportivo
Buckle	Hebilla
Buckle (To)	Abrocharse
Buckle the belt	Abrocharse la correa
Bumper	Parachoques
Bus driver	Chofer del bus
Buttocks	Trasero
Car	Carro

<b>English to Spanish Glossary</b>	
<b>English Word(s)</b>	<b>Spanish Translation</b>
Center front seat position	Posición del centro del asiento de enfrente
Certify, certified	Certificar, certificado
Check (To)	Comprobar, inspeccionar
Check with (To)	Comunicarse con
Checkup	Inspección
Chest	Pecho
Child	Niño
Child passenger safety class	Clase de seguridad para niños pasajeros
Child Passenger Safety Technician	Técnico de Seguridad para Pasajeros Niños
Child restraint checkup event	Evento de inspección de restricciones de niños
Child restraint crash tests	Pruebas de choque de restringidores de niños
Child restraint harness straps	Correas de arnés de las restricciones de niños
Child restraint industry	Industria de restricciones (sujetadores) de niños
Child restraint label	Etiqueta de la restricción de niños
Child restraint owner's manual	Manual de la restricción (¿del retenedor?) de niños
Child restraint systems	Sistemas de restricción de niños (Sistemas para sujetar a los niños)
Child restraints	Restricciones de niños (Sujetadores de niños)
Child safety	Seguridad de los niños
Child vehicle safety	Seguridad de los niños en los vehículos
Clip	Broche
Collapsible steering columns	Columnas de dirección plegables
Collar bone	Hueso del cuello
Colleague	Colega
Collision	Colisión, choque
Compartment	Compartimiento
Compliance	Estar de acuerdo con, estar conforme a, estar en cumplimiento de
Compliance testing	Pruebas sobre el cumplimiento de las reglas
Confiscate	Confiscar
Conventional	Convencionales
Cracked	Quebrado, con quebraduras
Cracks	Quebraduras
Crash forces	Fuerzas del choque
Crash protection	Protección contra choques
Crash, crashes	Choque, choques
Damage	Daño
Day care center	Centro de cuidado infantil
Deceleration	Desaceleración
Decrease (To)	Disminuir

<b>English to Spanish Glossary</b>	
<b>English Word(s)</b>	<b>Spanish Translation</b>
Defect	Defecto
Defect form	Formulario de defectos
Defects	Defectos
Degrees	Grados
Deploy (To)	Desplegarse
Disabled children	Niños impedidos
Do so safely (To)	Hacerlo de manera segura
Dummy	Maniquí
Ejection	Ser arrojado/a, ser tirado/a)
Emergency locking retractors	Retractores de agarre en emergencias
Encourage (To)	Alentar, animar, estimular
FAA (Federal Aviation Administration)	FAA (Siglas en inglés para la Administración Federal de Aviación)
Facing	Con cara a, mirando hacia, orientado hacia
Faded padding	Forro descolorido
Fail to	No lograr
Fall forward	Caerse hacia el frente
Fall forward	Caerse hacia delante
Fasten (To)	Abrochar
Fastened securely	Abrochado/a firmemente
Federal Motor Vehicle Safety Standard (FMVSS)	Norma (o Regla) Federal sobre la Seguridad de los Vehículos de Motor (FMVSS, por sus siglas en inglés)
Federal regulations	Regulaciones federales, reglamentaciones federales
Federal standards	Normas federales
Firmly positioned	Ajustados(as) firmemente
Flame retardant padding	Relleno que retarde el fuego
Flammability	Inflamabilidad
Force	Fuerza
Force (To)	Obligar
Force of deployment	Fuerza de despliegue
Force, forces	Fuerza, fuerzas
Forward	El frente, delantero
Forward anchor	Ancla del frente, ancla delantero
Forward facing	Con cara al frente, mirando hacia el frente, orientado hacia el frente
Forward facing child restraints	Restricciones de niños orientados hacia el frente
Forward motion	Movimiento hacia el frente
Fray (To)	Desgastarse, deshilacharse
Frayed area	Parte desgastada, parte deshilachada
Free-sliding latch plate	Plancha de abrocharse que se desliza fácilmente

<b>English to Spanish Glossary</b>	
<b>English Word(s)</b>	<b>Spanish Translation</b>
Front	Frente
Front (The)	La parte del frente
Front air bags	Bolsas de aire delanteras
Front bench seats	Asiento de banqueta (asiento largo) de enfrente
Front bucket seat of a vehicle	Asiento de tipo deportivo de enfrente
Front outboard passenger seat	Asiento del pasajero hacia fuera de enfrente
Front seat	Asiento del frente, asiento delantero
Frontal	Frontal, De frente
Gaze out (To)	Mirar hacia fuera
Give (To)	Ceder
Grasp (To)	Agarrar
Guarantee (To)	Garantizar
Harness retainer clip	Broche retenedor del arnés
Harness straps	Correas de arnés
Has not been tested	No ha sido probado
Head restraint	Sostén de cabeza
Heavy duty tape	Cinta engomada extra fuerte
Heavy-duty tape	Cinta engomada extra fuerte
High padded seat backs	Espaldares de asiento alto forrados
Highway	Carretera, autopista
Highway safety	Seguridad en las carreteras
Impact	Impacto
Improperly secured	Sujetado(a) inadecuadamente
Inboard	Del interior, de adentro, hacia adentro
Incorrectly installed, badly installed	Instalado incorrectamente, mal instalado
Incorrectly secured	Sujetado(a) incorrectamente
Increase (To)	Aumentar
Individual's weight	Peso del individuo
Infant	Niño, bebé
Infant	Bebé
Infant seat	Asiento de bebé
Injure himself / herself	Hacerse daño a sí mismo / misma
Injured	Lesionado/a, herido/a
Injury, injuries	Lesión, lesiones, daños, heridas
Integrated child restraint	Restricción de niños integrada al asiento
Integrated seat	Asiento integrado
Intentional, unintentional	Intencional, involuntario
Internal	Interno, interna (En el interior)
Internal harness	Arnés interno

<b>English to Spanish Glossary</b>	
<b>English Word(s)</b>	<b>Spanish Translation</b>
Lap	Falda, enfaldo, regazo, parte superior de los muslos
Lap and shoulder belt	Correa de regazo y hombros
Lap belt	Correa de regazo
Lap portion of the belt	Porción del regazo de la correa
Lap/shoulder belt	Correa de regazo/hombro
Large enough	Lo suficientemente grande
Latch plate	Plancha de abrocharse
Latch tongue side	Lado de la plancha para abrocharse
Laws	Leyes
Left rear passenger door	Puerta del pasajero del lado izquierdo trasero
Legal liability	Obligación legal
Liver	Hígado
Load limiters	Limitadores de carga
Lobby	Cabildear
Lock position	Posición cerrada (agarrada)
Locking clip	Broche de sujetar la correa
Locking latch plates	Planchas de abrocharse con cierre
Lower body	Parte baja del cuerpo
Lower hips	Parte debajo de las caderas
Manual lap belt	Correa de cintura manual
Manuals	Manuales
Manufactured by	Manufacturado por, fabricado por
Manufacturer	Fabricante
Manufacturer's labels	Etiquetas del fabricante (o del fabricante)
Mid-hips	A mitad de caderas
Minimize (To)	Minimizar
Minivan	Microbús
Monitors	Monitores
Motion sickness (To have)	Marearse
Motor vehicle collisions	Choques automovilísticos
Motor vehicle crashes	Choques automovilísticos
Motor vehicle, motor vehicles	Vehículo de motor, vehículos de motor
Newly manufactured	Manufacturado recientemente, fabricado recientemente
Not readable	No es leíble, no se puede leer
Older air bags	Bolsas de aire viejas
Outboard	Del exterior, de afuera, hacia fuera
Overall safety record	Historial de seguridad en general
Padded instrument panels	Paneles de instrumentos acolchonados
Padded seat backs	Espaldares forrados

<b>English to Spanish Glossary</b>	
<b>English Word(s)</b>	<b>Spanish Translation</b>
Parents and other caregivers	Padres y demás cuidadores de niños
Passage of laws	Promulgación de leyes
Passage of legislation	Aprobación de legislación
Passenger	Pasajero
Passenger vehicles	Vehículos de pasajeros
Passenger vehicles	Vehículos de pasajeros
Paternal values	Valores de los padres
Pliable plastic shell	Armazón de plástico plegable
Police patrol cars	Carros de patrulla de la policía
Position (To)	Situar, ubicar, colocar, poner
Position the seat	Colocar el asiento, acomodar el asiento
Pre-crash speed	Velocidad antes del choque
Prevent (To)	Evitar, impedir
Printed handouts	Materiales impresos
Prisoner screen	Pantalla para prisioneros
Protect (To)	Proteger
Protruding	Sobresaliendo, que sobresale
Provision	Medida, disposición, cláusula, estipulación, condición
Ratchet mechanism	Mecanismo de engranaje
Rear (The)	La parte de atrás
Rear bench seats	Asiento de banqueta (asiento largo) de atrás
Rear seat position	Posición del asiento de atrás
Rear window	Ventana trasera
Rear-end impacts	Impactos en la parte de atrás
Rear-ending the vehicle	Chocar la parte de atrás del vehículo
Rear-facing infant seat	Asiento de bebé orientado hacia atrás
Re-buckle the belt	Abrocharse de nuevo el cinturón
Recalls	Llamadas para la devolución
Recline adjustment mechanism	Mecanismo para ajustar el declive
Reel	Carrete, bobina
Regular locking clip	Broche corriente de ajustar la correa
Regulation	Regla
Release the seat belt	Desabrochar (soltar) el cinturón del asiento
Replacement	Reemplazo
Restrain (To)	Restringir, limitar (Sujetar)
Restrained, unrestrained	Restringidos, no restringidos (Sujetados, no sujetos)
Restraint	Restricción (Sujetador)
Restraint base	Base de la restricción
Restraint systems	Sistemas de restringir (Sistemas de sujetar o sujetadores)

## English to Spanish Glossary

English Word(s)	Spanish Translation
Retainer	Retenedor
Retract (To)	Desenrollar
Review	Repasar
Ribs	Costillas
Rolled towel	Toalla enrollada
Rotational spin	Giro rotatorio
Safety	Seguridad
Safety rationale	Fundamento de seguridad
Safety seat harness	Arnés del asiento de seguridad
Scantron Sheet	Hoja Scantron
School bus seats	Asientos de autobús escolar
School Buses	Autobuses escolares
Seat	Asiento
Seat back	Espaldar del asiento
Seat belt	Cinturón del asiento
Seat belt system	Sistema de cinturones de asientos
Seat bight	Recodo del asiento
Seat's padding	Forro del asiento
Second hand child restraint	Restricción de niños de segunda mano
Second-hand	De segunda mano
Secure (To)	Asegurar (sujetar)
Secure from (To)	Proteger contra
Secure it	Sujetarlo(a)
Securing	Estar asegurando (estar sujetando)
Seriously	Seriamente
Several inches thick	Varias pulgadas de espesor
Shell	Armazón
Shield booster seat	Asiento elevado con protector
Shoulder belt positioners	Acomodadores de cinturón de hombro
Shoulder restraint	Restricción de hombro
Shoulder, shoulders	Hombro, hombros
Side (The)	La parte del lado
Side impact crash	Choque con el impacto en el lado, choque por el lado
Side window	Ventana del lado
Side-facing jump seat	Asiento de acceso orientado hacia el lado
Side-facing seats	Asientos orientados hacia el lado
Silicone caulking	Pasta silicona
Slack	Estar holgado, suelto
Slight indentation	Hundimiento leve

## English to Spanish Glossary

English Word(s)	Spanish Translation
Slip (To)	Deslizar, acomodar, escurrir
Snugly	Ajustadamente
Special training	Entrenamiento especial
Spool (To)	Enrollar
Spread (To)	Distribuir
Standard	Norma, regla
Standardization	Normalización
Statement	Declaración, planteamiento, afirmación
Station Wagon	Carro camioneta, automóvil camioneta
Stopping distance	Distancia en detenerse
Store	Tienda
Strike (To)	Golpear
Striking	Golpeando
Stronger	Más fuerte
Sudden stop	Parada repentina, detenerse repentinamente
Supplemental	Suplementario
Switchable latch plates	Planchas de abrocharse cambiables
Switchable retractor	Retractor cambiable
Technician	Técnico
Testing	Hacer pruebas
Testing process	Transcurso de la prueba
Tests	Pruebas, exámenes
Tether	Cuerda
Tether anchor strap	Correa de anclar de cuerda
Tether strap	Correa de cuerda
The retractor locks	El retractor se cierra, se agarra, se tranca
Thighs	Muslos
Thread it through	Enhebrar (pasar) a través
Three-point restraint	Restricción de tres puntos
To record	Apuntar, anotar, grabar
Transfer, transferred	Transferir, transfirió
Transportation to and from school	Transportación yendo y viniendo de la escuela
Trapped	Atrapado/a
Tree limb	Rama de árbol
Tug (To)	Halar
Two-point seat belt	Correa de asiento de dos puntos
Unbuckle	Desabrochar
Unlocked position	Posición abierta (suelta)
Unrestrain (To)	Dejar de restringir, dejar de limitar (Dejar de sujetar)

## English to Spanish Glossary

English Word(s)	Spanish Translation
Unrestrained occupants	Pasajeros que no están restringidos (sujetados)
Update (To)	Acción de ponerse al día
Upper thighs	Parte de arriba de los muslos
Upright forward-facing position	Posición erguida orientada hacia el frente
Upward	Hacia arriba
Vehicle comes to a complete stop	El vehículo se detiene completamente
Vehicle compatibility	Compatibilidad del vehículo
Vehicle design	Diseño de vehículos
Vehicle features	Aditamentos de automóvil
Vehicle owner's manual	Manual del vehículo
Vehicle seat bight	Recodo del asiento del vehículo
Vehicular crash	Choque de vehículos
Vouchers	Comprobantes
Waiver of liability of claim	Declaración de renuncia al derecho de reclamo
Warning labels	Etiquetas de advertencia
Warning systems	Sistemas de advertencia
Webbing	Tejido de la correa
Weight of the object struck	Peso del objeto golpeado
Weight of the occupant	Peso del pasajero
Whiplash	Torcedura del cuello
Wiggle out	Zafarse
Windshield	Parabrisas
With restraints	Con restricciones (sujetado/a)

**PREVIEW COPY**

## Spanish to English Glossary

Spanish Word(s)	English Translation
A mitad de caderas	Mid-hips
Abdomen	Abdomen
Abrochado/a firmemente	Fastened securely
Abrochar	Fasten (To)
Abrocharse	Buckle (To)
Abrocharse de nuevo el cinturón	Re-buckle the belt
Abrocharse la correa	Buckle the belt
Acción de ponerse al día	Update (To)
Acomodadores de cinturón de hombro	Shoulder belt positioners
Aditamentos de automóvil	Vehicle features
Agarrar	Grasp (To)
Agarrarse automáticamente	Automatically lock
Ajustadamente	Snugly
Ajustados(as) firmemente	Firmly positioned
Alentar, animar, estimular	Encourage (To)
Ancla del frente, ancla delantero	Forward anchor
Anclas	Anchors
Aprobación de legislación	Passage of legislation
Apuntar, anotar, grabar	To record
Armazón	Shell
Armazón de plástico plegable	Pliable plastic shell
Arnés de 5 puntos	5-point harness
Arnés del asiento de seguridad	Safety seat harness
Arnés interno	Internal harness
Asegurar (sujetar)	Secure (To)
Asiento	Seat
Asiento de acceso orientado hacia el lado	Side-facing jump seat
Asiento de automóvil de banqueta (asiento largo)	Bench seat
Asiento de automóvil deportivo	Bucket seat
Asiento de banqueta (asiento largo) de enfrente	Front bench seats
Asiento de banqueta (asiento largo) de atrás	Rear bench seats
Asiento de bebé	Infant seat
Asiento de bebé orientado hacia atrás	Rear-facing infant seat
Asiento de tipo deportivo de enfrente	Front bucket seat of a vehicle
Asiento del frente, asiento delantero	Front seat
Asiento del pasajero hacia fuera de enfrente	Front outboard passenger seat
Asiento elevado ajustado con correas	Belt-positioning booster seat
Asiento elevado con protector	Shield booster seat

## Spanish to English Glossary

Spanish Word(s)	English Translation
Asiento integrado	Integrated seat
Asientos de autobús escolar	School bus seats
Asientos orientados hacia el lado	Side-facing seats
Asimétrico	Asymmetrical
Atrapado/a	Trapped
Aumentar	Increase (To)
Autobuses escolares	School Buses
Base de la restricción	Restraint base
Bebé	Infant
Bolsas de aire “inteligentes”	“Smart” air bags
Bolsas de aire	Air bags
Bolsas de aire delanteras	Front air bags
Bolsas de aire viejas	Older air bags
Broche	Clip
Broche corriente de ajustar la correa	Regular locking clip
Broche de sujetar la correa	Locking clip
Broche para acortar la correa	Belt shortening clip
Broche retenedor del arnés	Harness retainer clip
Cabildear	Lobby
Caerse hacia delante	Fall forward
Caerse hacia el frente	Fall forward
Cantidad de soltura de la correa del asiento	Amount of slack in the seat belt
Carrete, bobina	Reel
Carretera, autopista	Highway
Carro	Car
Carro camioneta, automóvil camioneta	Station Wagon
Carros de patrulla de la policía	Police patrol cars
Ceder	Give (To)
Centro de cuidado infantil	Day care center
Certificar, certificado	Certify, certified
Chocar la parte de atrás del vehículo	Rear-ending the vehicle
Chofer del bus	Bus driver
Choque, choques	Crash, crashes
Choque con el impacto en el lado, choque por el lado	Side impact crash
Choque de vehículos	Vehicular crash
Choques automovilísticos	Automobile crashes
Choques automovilísticos	Motor vehicle collisions
Choques automovilísticos	Motor vehicle crashes
Cinta engomada extra fuerte	Heavy duty tape

## Spanish to English Glossary

Spanish Word(s)	English Translation
Cinta engomada extra fuerte	Heavy-duty tape
Cinturón del asiento	Seat belt
Clase de seguridad para niños pasajeros	Child passenger safety class
Colega	Colleague
Colisión, choque	Collision
Colocar el asiento, acomodar el asiento	Position the seat
Columnas de dirección plegables	Collapsible steering columns
Compartimiento	Compartment
Compatibilidad del vehículo	Vehicle compatibility
Comprobantes	Vouchers
Comprobar, inspeccionar	Check (To)
Comunicarse con	Check with (To)
Con cara a, mirando hacia, orientado hacia	Facing
Con cara al frente, mirando hacia el frente, orientado hacia el frente	Forward facing
Con restricciones (sujetado/a)	With restraints
Confiscar	Confiscate
Convencionales	Conventional
Correa	Belt
Correa de anclar	Anchor strap
Correa de anclar de cuerda	Tether anchor strap
Correa de asiento de dos puntos	Two-point seat belt
Correa de cintura manual	Manual lap belt
Correa de cuerda	Tether strap
Correa de regazo/hombro	Lap/shoulder belt
Correa de regazo	Lap belt
Correa de regazo y hombros	Lap and shoulder belt
Correas de arnés de las restricciones de niños	Child restraint harness straps
Correas de arnés	Harness straps
Costillas	Ribs
Cuerda	Tether
Daño	Damage
De segunda mano	Second-hand
Declaración de renuncia al derecho de reclamo	Waiver of liability of claim
Declaración, planteamiento, afirmación	Statement
Defecto	Defect
Defectos	Defects
Dejar de restringir, dejar de limitar (Dejar de sujetar)	Unrestrain (To)
Del exterior, de afuera, hacia fuera	Outboard

<b>Spanish to English Glossary</b>	
<b>Spanish Word(s)</b>	<b>English Translation</b>
Del interior, de adentro, hacia adentro	Inboard
Desabrochar	Unbuckle
Desabrochar (soltar) el cinturón del asiento	Release the seat belt
Desaceleración	Deceleration
Desenrollar	Retract (To)
Desgastarse, deshilacharse	Fray (To)
Deslizar, acomodar, escurrir	Slip (To)
Desplegarse	Deploy (To)
Despliegue de la bolsa de aire	Air bag deployment
Diseño de vehículos	Vehicle design
Disminuir	Decrease (To)
Distancia en detenerse	Stopping distance
Distribuir	Spread (To)
El frente, delantero	Forward
El retractor se cierra, se agarra, se tranca	The retractor locks
El vehículo se detiene completamente	Vehicle comes to a complete stop
Enhebrar (pasar) a través	Thread it through
Enrollar	Spool (To)
Entrenamiento especial	Special training
Espaldar del asiento	Seat back
Espaldares de asiento alto forrados	High padded seat backs
Espaldares forrados	Padded seat backs
Estar asegurando (estar sujetando)	Securing
Estar de acuerdo con, estar conforme a, estar en cumplimiento de	Compliance
Estar holgado, suelto	Slack
Etiqueta de la restricción de niños	Child restraint label
Etiquetas de advertencia	Warning labels
Etiquetas del fabricante (o del fabricante)	Manufacturer's labels
Evento de inspección de restricciones de niños	Child restraint checkup event
Evitar, impedir	Prevent (To)
FAA (Siglas en inglés para la Administración Federal de Aviación)	FAA (Federal Aviation Administration)
Fabricante	Manufacturer
Falda, enfaldo, regazo, parte superior de los muslos	Lap
Formulario de defectos	Defect form
Forro del asiento	Seat's padding
Forro descolorido	Faded padding
Forros acolchonados adicionales	Additional padding

<b>Spanish to English Glossary</b>	
<b>Spanish Word(s)</b>	<b>English Translation</b>
Frente	Front
Frontal, De frente	Frontal
Fuerza	Force
Fuerza de despliegue	Force of deployment
Fuerza, fuerzas	Force, forces
Fuerzas del choque	Crash forces
Fundamento de seguridad	Safety rationale
Garantizar	Guarantee (To)
Giro rotatorio	Rotational spin
Golpeando	Striking
Golpear	Strike (To)
Grados	Degrees
Habilidad para pagarlo	Affordability
Hacer pruebas	Testing
Hacerlo de manera segura	Do so safely (To)
Hacerse daño a sí mismo / misma	Injure himself / herself
Hacia arriba	Upward
Halar	Tug (To)
Hebilla	Buckle
Hígado	Liver
Historial de seguridad en general	Overall safety record
Hoja Scantron	Scantron Sheet
Hombro, hombros	Shoulder, shoulders
Hueso del cuello	Collar bone
Hundimiento leve	Slight indentation
Impacto	Impact
Impactos en la parte de atrás	Rear-end impacts
Industria de restricciones (sujetadores) de niños	Child restraint industry
Inflamabilidad	Flammability
Inspección	Checkup
Instalado incorrectamente, mal instalado	Incorrectly installed, badly installed
Intencional, involuntario	Intentional, unintentional
Interno, interna (En el interior)	Internal
La parte de atrás	Rear (The)
La parte del frente	Front (The)
La parte del lado	Side (The)
Lado de la plancha para abrocharse	Latch tongue side
Lápiz de grafito #2	#2 Lead Pencil
Lesión, lesiones, daños, heridas	Injury, injuries

<b>Spanish to English Glossary</b>	
<b>Spanish Word(s)</b>	<b>English Translation</b>
Lesionado/a, herido/a	Injured
Leyes	Laws
Limitadores de carga	Load limiters
Llamadas para la devolución	Recalls
Lo suficientemente grande	Large enough
Maniquí	Dummy
Manual de la restricción (¿del retenedor?) de niños	Child restraint owner's manual
Manual del vehículo	Vehicle owner's manual
Manuales	Manuals
Manufacturado por, fabricado por	Manufactured by
Manufacturado recientemente, fabricado recientemente	Newly manufactured
Manufactureros (o fabricantes) de automóviles	Automobile manufacturers
Marearse	Motion sickness (To have)
Más fuerte	Stronger
Materiales impresos	Printed handouts
Mecanismo de engranaje	Ratchet mechanism
Mecanismo para ajustar el declive	Recline adjustment mechanism
Medida, disposición, cláusula, estipulación, condición	Provision
Microbús	Minivan
Minimizar	Minimize (To)
Mirar hacia fuera	Gaze out (To)
Monitores	Monitors
Movimiento hacia el frente	Forward motion
Muslos	Thighs
Niño	Child
Niño, bebé	Infant
Niños impedidos	Disabled children
Nivel de la axila	Armpit level
No es leíble, no se puede leer	Not readable
No ha sido probado	Has not been tested
No lograr	Fail to
Norma (o Regla) Federal sobre la Seguridad de los Vehículos de Motor (FMVSS, por sus siglas en inglés)	Federal Motor Vehicle Safety Standard (FMVSS)
Norma, regla	Standard
Normalización	Standardization
Normas federales	Federal standards

## Spanish to English Glossary

Spanish Word(s)	English Translation
Obligación legal	Legal liability
Obligar	Force (To)
Padres y demás cuidadores de niños	Parents and other caregivers
Paneles de instrumentos acolchonados	Padded instrument panels
Pantalla para prisioneros	Prisoner screen
Parabrisas	Windshield
Parachoques	Bumper
Parada repentina, detenerse repentinamente	Sudden stop
Parte baja del cuerpo	Lower body
Parte de arriba de los muslos	Upper thighs
Parte debajo de las caderas	Lower hips
Parte desgastada, parte deshilachada	Frayed area
Pasajero	Passenger
Pasajero adulto	Adult vehicle occupant
Pasajeros que no están restringidos (sujetados)	Unrestrained occupants
Pasta silicona	Silicone caulking
Pecho	Chest
Peso del individuo	Individual's weight
Peso del objeto golpeado	Weight of the object struck
Peso del pasajero	Weight of the occupant
Plancha de abrocharse que se desliza fácilmente	Free-sliding latch plate
Plancha de abrocharse	Latch plate
Plancha del ancla	Anchor plate
Planchas de abrocharse con cierre	Locking latch plates
Planchas de abrocharse cambiables	Switchable latch plates
Porción del regazo de la correa	Lap portion of the belt
Posición abierta (suelta)	Unlocked position
Posición cerrada (agarrada)	Lock position
Posición del asiento de atrás	Rear seat position
Posición del centro del asiento de enfrente	Center front seat position
Posición erguida orientada hacia el frente	Upright forward-facing position
Productos hechos después de la fabricación original	After market products
Productos hechos posteriormente	After market products
Promulgación de leyes	Passage of laws
Protección contra choques	Crash protection
Proteger	Protect (To)
Proteger contra	Secure from (To)

<b>Spanish to English Glossary</b>	
<b>Spanish Word(s)</b>	<b>English Translation</b>
Pruebas de choque de restringidores de niños	Child restraint crash tests
Pruebas, exámenes	Tests
Pruebas sobre el cumplimiento de las reglas	Compliance testing
Puerta del pasajero del lado izquierdo trasero	Left rear passenger door
Quebrado, con quebraduras	Cracked
Quebraduras	Cracks
Rama de árbol	Tree limb
Recodo del asiento	Seat bight
Recodo del asiento del vehículo	Vehicle seat bight
Reemplazo	Replacement
Regla	Regulation
Regulaciones federales, reglamentaciones federales	Federal regulations
Relleno que retarde el fuego	Flame retardant padding
Repasar	Review
Restricción (Sujetador)	Restraint
Restricción de hombro	Shoulder restraint
Restricción de niños integrada al asiento	Integrated child restraint
Restricción de niños de segunda mano	Second hand child restraint
Restricción de tres puntos	Three-point restraint
Restricciones de niños (Sujetadores de niños)	Child restraints
Restricciones de niños orientados hacia el frente	Forward facing child restraints
Restringidos, no restringidos (Sujetados, no sujetos)	Restrained, unrestrained
Restringir, limitar (Sujetar)	Restrain (To)
Retenedor	Retainer
Retractor cambiabile	Switchable retractor
Retractor de agarre automático	Automatic locking retractor (ALR)
Retradores de agarre en emergencias	Emergency locking retractors
Rozar	Brush against (To)
Seguridad	Safety
Seguridad de los niños	Child safety
Seguridad de los niños en los vehículos	Child vehicle safety
Seguridad en las carreteras	Highway safety
Ser arrojado del carro	Being thrown out of the car
Seriamente	Seriously
Sistema de cinturones de asientos	Seat belt system
Sistema de restricción automático	Automatic restraint system
Sistemas de advertencia	Warning systems

<b>Spanish to English Glossary</b>	
<b>Spanish Word(s)</b>	<b>English Translation</b>
Sistemas de anclaje, sistemas para anclar	Anchorage systems
Sistemas de restricción de niños (Sistemas para sujetar a los niños)	Child restraint systems
Sistemas de restringir (Sistemas de sujetar o sujetadores)	Restraint systems
Situación, ubicar, colocar, poner	Position (To)
Sobresaliendo, que sobresale	Protruding
Sostén de cabeza	Head restraint
Ser arrojado/a, ser tirado/a)	Ejection
Sujetado(a) inadecuadamente	Improperly secured
Sujetado(a) incorrectamente	Incorrectly secured
Sujetarlo(a)	Secure it
Suplementario	Supplemental
Tan apretadamente como sea posible	As tightly as possible
Técnico	Technician
Técnico de Seguridad para Pasajeros Niños	Child Passenger Safety Technician
Tejido de la correa	Webbing
Tienda	Store
Toalla enrollada	Rolled towel
Torcedura del cuello	Whiplash
Transcurso de la prueba	Testing process
Transferir, transfirió	Transfer, transferred
Transportación yendo y viniendo de la escuela	Transportation to and from school
Trasero	Buttocks
Trayectoria del cinturón	Belt path
Valores de los padres	Paternal values
Varias pulgadas de espesor	Several inches thick
Vehículo de motor, vehículos de motor	Motor vehicle, motor vehicles
Vehículos de pasajeros	Passenger vehicles
Vehículos de pasajeros	Passenger vehicles
Velocidad antes del choque	Pre-crash speed
Ventana del lado	Side window
Ventana trasera	Rear window
Zafarse	Wiggle out

**PREVIEW COPY**