

Ride Safe

Information to help you travel more safely
in motor vehicles while seated in your wheelchair.



Rehabilitation Engineering Research Center
on Wheelchair Transportation Safety



University of Michigan
Health System

University of Michigan
Transportation Research Institute

Initially funded through a grant from the FRIENDS
of the University of Michigan Hospitals

2005

When traveling in a motor vehicle, it is generally safest for wheelchair users to transfer to a vehicle seat and use the vehicle seatbelt system or a child safety seat that complies with federal safety standards. The wheelchair should then be stored and secured in the vehicle.

If transferring is not feasible, it is very important to secure the wheelchair to the vehicle facing forward and to use crash-tested seatbelts for the wheelchair-seated rider.



START WITH THE RIGHT EQUIPMENT

The Wheelchair

It is best if you have a wheelchair that has been designed and tested for use as a seat in motor vehicles, often referred to as a **WC19 wheelchair or a transit wheelchair**. These wheelchairs comply with ANSI/RESNA WC19, a voluntary standard developed by safety and rehabilitation experts. Wheelchairs that meet the design and performance requirements of this standard will be labeled to show that they comply with WC19.

Most importantly, a WC19 wheelchair has four, crash-tested securement points where tiedown straps and hooks can be easily attached. These points are clearly marked with a hook symbol.

If a WC19 wheelchair is not available, the next best choice is a wheelchair with an accessible metal frame where tiedown straps and hooks can be attached at frame junctions.

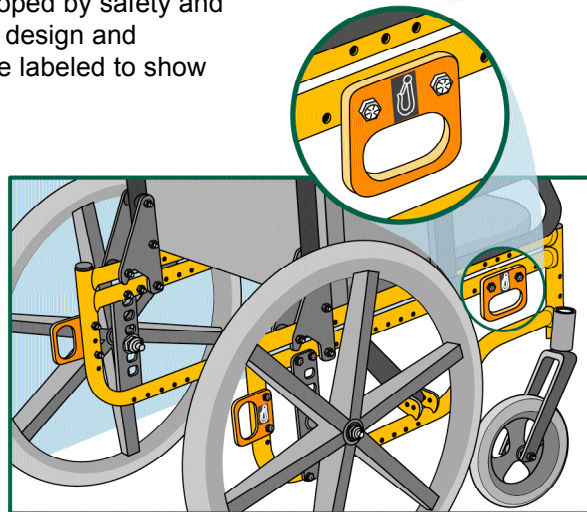

The Wheelchair Tiedown and Occupant Restraint System (WTORS)

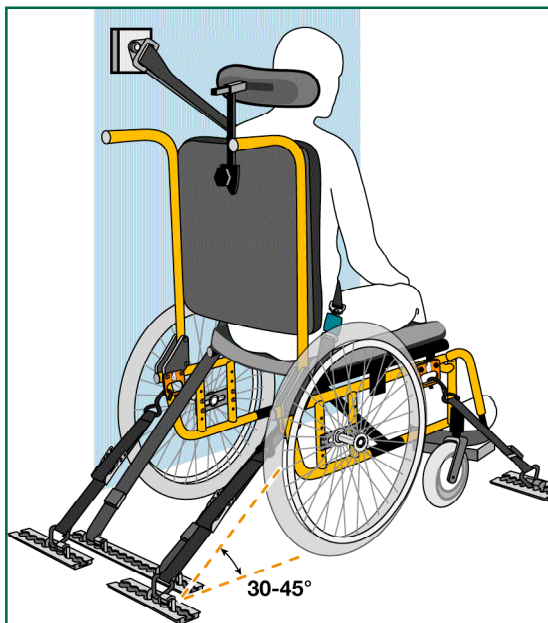

It is important to use a complete WTORS to secure the wheelchair and provide the wheelchair occupant with a properly designed and tested seatbelt system.

Always use a WTORS that has been crash tested and labeled as complying with SAE J2249, a voluntary standard developed by safety and rehabilitation experts. The most common type of wheelchair tiedown uses four straps to secure the wheelchair to the vehicle. Although it requires someone other than the wheelchair rider to secure and release the wheelchair, this tiedown can secure a wide range of WC19 and non-WC19 wheelchairs.

To protect the rider during a crash or sudden braking, and to minimize the likelihood of injury caused by contact with the vehicle, a seatbelt system with both pelvic and upper torso belts must be used.

2

SECURE THE WHEELCHAIR

Four-Point Tiedowns

- ▶ Always position the wheelchair and rider facing forward in the vehicle.
- ▶ When securing a WC19 wheelchair, attach the four tiedown straps to the securement points provided on the wheelchair. Tighten the straps to remove all slack.

▶ If you do not have a WC19 wheelchair, it is best to attach the tiedown straps to welded junctions of the wheelchair frame or to other structural areas where the frame is fastened together with hardened steel bolts indicated by six raised lines or bumps on the bolt head.

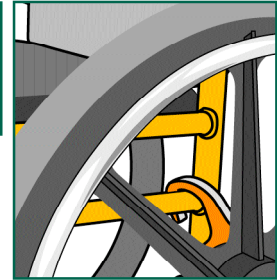
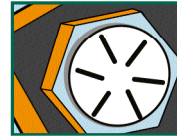

▶ **Do not attach tiedowns to adjustable, moving, or removable parts of the wheelchair such as armrests, footrests, and wheels.**

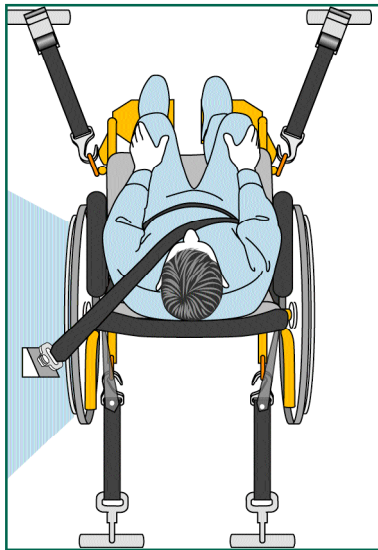

▶ When securing non-WC19 wheelchairs, choose structural securement points as close to the seat surface as possible to provide greater wheelchair stability during travel. It is best if the rear securement points are high enough to result in angles of the rear tiedown straps between 30 and 45 degrees to the horizontal.

▶ If you have a non-WC19 wheelchair with a tilt seat, make sure to attach both the front and rear straps to either the seat frame or to the base frame. Mixing wheelchair securement points between the seat and base can result in the tiedown straps becoming slack if the angle of the seat changes during a crash.

▶ It is best if floor anchor points for rear tiedown straps are located directly behind the rear securement points on the wheelchair. If possible, the front tiedown straps should anchor to the floor at points that are spaced wider than the wheelchair to increase lateral stability during travel.

Other Methods of Wheelchair Securement

▶ In addition to securing wheelchairs using a four-point tiedown, wheelchairs can also be secured using a docking tiedown device. This method is primarily used in private vehicles since it requires the addition of adaptor hardware to the wheelchair frame that will engage with the docking tiedown device in the vehicle. Docking securement devices allow the wheelchair rider to secure and release the wheelchair without assistance.

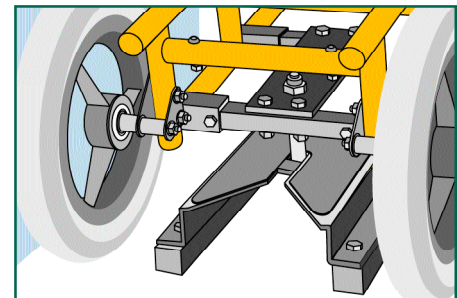

▶ If you plan to secure your wheelchair with a docking tiedown device, you should check with the WTORS or wheelchair manufacturer to ensure that your wheelchair model has been successfully crash tested with their system.

▶ Clamp-type securement devices are not recommended since they do not provide effective wheelchair securement in frontal crash testing.

3

PROTECT THE WHEELCHAIR RIDER

▶ In addition to securing the wheelchair, **it is very important to provide effective restraint for the wheelchair user with a crash-tested lap and shoulder belt or with a child restraint harness.**

Postural support belts attached to the wheelchair are not strong enough to withstand the forces of a crash and are usually not positioned correctly to restrain the occupant safely in a crash.

▶ The lap belt should be placed low across the front of the pelvis near the upper thighs, not high over the abdomen. When possible, the lap belt should be angled between 45 and 75 degrees to the horizontal when viewed from the side. Some wheelchair features, like armrests, can interfere with good belt fit. To avoid placing the lap belt over the armrest and to keep the lap belt low on the pelvis, it may be necessary to insert the belt between the armrest and the seatback, or through an opening under the armrest.

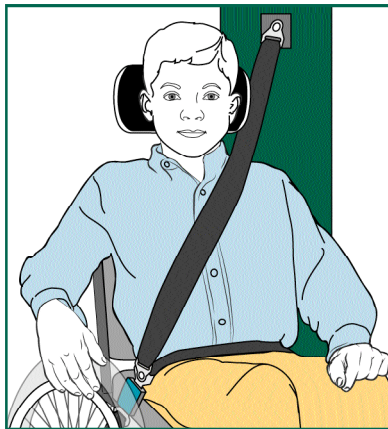
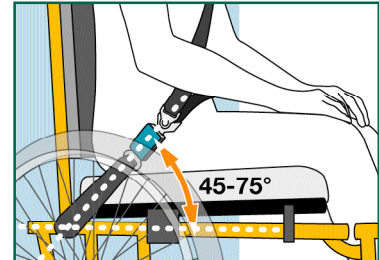

▶ A diagonal shoulder belt should cross the middle of the shoulder and the center of the chest, and should connect to the lap belt near the hip of the wheelchair rider. The upper shoulder-belt anchor point or D-ring guide should be anchored above and behind the top of the occupant's shoulder, so that the belt is in good contact with the shoulder and chest while traveling.

▶ Newer WC19 wheelchairs offer the option of a crash-tested lap belt that is anchored to the wheelchair frame. If the wheelchair has an onboard crash-tested lapbelt, complete the belt system by attaching the lower end of a shoulder belt to the lap belt. Crash-tested wheelchair-anchored lap belts will be labeled to indicate that they comply with with ANSI/RESNA WC19.

Other Important Points

- Read and follow all manufacturers' instructions.
- It is best to ride with the wheelchair backrest positioned at an angle of 30 degrees or less to the vertical. If a greater recline angle is needed, the shoulder belt anchor point should be moved rearward along the vehicle sidewall so the belt maintains contact with the rider's shoulder and chest.
- Maximize the clear space around the rider to reduce the possibility of contact with vehicle components and other passengers in a crash. Cover vehicle components that are close to the rider with dense padding.
- Check WTORS equipment regularly and replace worn or broken components. Keep anchorage track free of dirt and debris.
- If a WTORS and wheelchair have been involved in a vehicle crash, check with the manufacturers to determine if the equipment needs to be repaired or replaced.
- If possible, remove hard trays and secure them elsewhere in the vehicle to reduce the chance of rider injury from contact with the tray. Consider the use of foam trays instead of rigid trays during transit. If it is not possible to remove a hard tray, place dense padding between the rider and the tray and make sure that the tray is securely attached to the wheelchair so it will not break loose and cause injury to other occupants in a crash.
- A properly positioned headrest can help protect the neck in a rear impact.
- If it is necessary to use a head and neck support during travel, soft neck collars are safer than stiff collars or head straps which could cause neck injury in a crash. The soft collar should not be attached to the seating system.
- Secure medical and other equipment to the wheelchair or vehicle to prevent it from breaking loose and causing injuries in a crash.



RESOURCES

Organizations

Rehabilitation Engineering and Research Center on
Wheelchair Transportation Safety
www.ercwts.pitt.edu

University of Michigan Transportation Research Institute
www.umtri.umich.edu

University of Pittsburgh
www.wheelchairnet.org

Society of Automotive Engineers
www.sae.org

RESNA Rehabilitation Engineering Society of North
America
www.resna.org

National Highway Traffic Safety Administration
www.nhtsa.dot.gov

National Mobility Equipment Dealer's Association
www.nmeda.org

The Association for Driver Rehabilitation Specialists
www.driver-ed.org

A Helpful Publication

School Bus Transportation of Students in Wheelchairs

A manual of procedures and practices used by the Washtenaw Intermediate School District for providing effective wheelchair securement and occupant restraint.

Washtenaw Intermediate School District
734-994-8100
www.wash.k12.mi.us

Wheelchair Manufacturers (Ask for Frames and/or Seating Products that Comply with WC19)

Convaid
www.convaid.com; 800-266-8243

Freedom Designs
www.freedomdesigns.com; 800-331-8551

GOVAN + wheelchair and docking system
www.smd-abitech.com; 204-975-3004

Invacare
www.invacare.com; 800-333-6900

Mulholland Positioning Systems
www.mulhollandinc.com; 800-543-4769

Otto Bock
www.ottobock.com; 800-328-4058

Permobil
www.permobil.com; 800-736-0925

Pride Mobility
www.pridemobility.com; 800-800-8586

Sammons Preston
www.sammonspreston.com; 800-323-5547

Sunrise Medical
www.sunrisemedicalonline.com; 800-333-4000

Wheelchair Seating Manufacturers (Ask for Products that have been Tested to WC19)

Adaptive Engineering Lab
www.aelseating.com; 800-327-6080

Adaptive Equipment Systems
www.aesys.com; 800-237-2370

Wheelchair Tiedown and Occupant Restraint Manufacturers (Ask for Products that Comply with SAE J2249)

Creative Controls
www.creativecontrolsinc.com; 800-539-7237

EZ-Lock
www.ezlock.net; 225-214-4620

Orthosafe
www.orthosafe.com; 609-587-9444

Q'Straint
www.qstraint.com; 800-987-9987

SureLok
www.sure-lok.com; 866-787-3565



GLOSSARY OF TERMS

Anchor point: The location on a vehicle, wheelchair, or wheelchair tiedown where a belt-restraint or wheelchair-tiedown anchorage is attached.

ANSI-RESNA WC19 (officially, SECTION 19 ANSI/RESNA WC/VOL. 1 *Wheelchairs for use in Motor Vehicles*): A voluntary standard for wheelchairs designed for use when traveling facing forward in a motor vehicle. NOTE: ISO 7176/19 is an international transit wheelchair standard that specifies similar design and performance requirements as ANSI/RESNA WC19.

Belt: A length of energy-absorbing webbing material used in occupant restraint systems.

Docking tiedown: A method for securing wheelchairs where portions of the wheelchair frame, or add-on components fastened to the wheelchair frame, engage with a securement device anchored to the vehicle.

Four-point strap-type tiedown: A method for securing a wheelchair where four straps are attached to the wheelchair at four separate securement points and attached to the vehicle at four separate anchor points.

Occupant restraint: A system or device designed to restrain a motor vehicle occupant in a crash by keeping the occupant in the vehicle seat and minimizing contact with the vehicle interior, other occupants, or objects outside the vehicle.

Postural support: A padded component and/or belt used to help maintain a person in a desired position during normal wheelchair use. In general postural supports are **not** designed to provide effective occupant restraint in a motor vehicle crash.

SAE Recommended Practice J2249 (officially, SAE J2249 *Wheelchair Tiedowns and Occupant Restraints for Use in Motor Vehicles*): A Society of Automotive Engineers Recommended Practice that specifies design and performance requirements for wheelchair tiedown and occupant restraint systems. NOTE: ISO 10542 is an international WTORS standard that specifies comparable design and performance requirements as SAE J2249.

Securement points: Specific structural points on the wheelchair base or seat frame that are designed for attachment of wheelchair tiedowns.

Strap: A length of webbing material used in wheelchair tiedown systems.

WC19 wheelchair: A crash-tested wheelchair with four clearly identified securement points that meets the design and performance requirements of ANSI-RESNA WC19 Wheelchairs Used as Seats in Motor Vehicles, and is sometimes called a transit wheelchair.

Wheelchair tiedown and occupant-restraint system (WTORS): A complete system for use by wheelchair-seated occupants comprised of a system or device for securing the wheelchair and a belt-type restraint system for limiting occupant movement in a motor vehicle crash.

Regents of the University of Michigan

David A. Brandon, Ann Arbor; Laurence B. Deitch, Bingham Farms; Olivia P. Maynard, Goodrich; Rebecca McGowan, Ann Arbor; Andrea Fischer Newman, Ann Arbor; Andrew C. Richner, Grosse Pointe Park; S. Martin Taylor, Grosse Pointe Farms; Katherine E. White, Ann Arbor; Mary Sue Coleman (ex officio)

The University of Michigan, as an equal opportunity/affirmative action employer, complies with all applicable federal and state laws regarding nondiscrimination and affirmative action, including Title IX of the Education Amendments of 1972 and Section 504 of the Rehabilitation Act of 1973. The University of Michigan is committed to a policy of nondiscrimination and equal opportunity for all persons regardless of race, sex, color, religion, creed, national origin or ancestry, age, marital status, sexual orientation, disability, or Vietnam-era veteran status in employment, educational programs and activities, and admissions. Inquiries or complaints may be addressed to the University's Director of Affirmative Action and Title IX/Section 504 Coordinator, at the Office of Multicultural Community, 2072 Administrative Services Building, Ann Arbor, Michigan 48109-1432, 734-763-0235, TTY 734-647-1388. For other University of Michigan information, call 734-764-1817.